

E.C.A.[®]

Confeo Premix

**CONFEO PREMIX
CONDENSING COMBI BOILER**

CONFEO PREMIX P 14/20/24/28/30/35 HM/HCH/HST

**OPERATING &
INSTALLATION MANUAL**



Building Regulations and the Benchmark Commissioning Checklist
Building Regulations (England & Wales) require notification of the installation of a heating appliance to the relevant Local Authority Building Control Department. This can be achieved via a Competent Persons Self Certification Scheme as an option to notifying the Local Authority directly.

The Health & Safety Executive operates the 'Gas Safe Register', a self certification scheme for gas heating appliances.

This company is a member of the Benchmark initiative and fully supports the aims of the programme. Its aim is to improve the standards of installation and commissioning of central heating systems in the UK and to encourage the regular servicing of all central heating systems to ensure safety and efficiency. Building Regulations require that installations should comply with manufacturer's instructions. It is therefore important that the commissioning checklist is completed by the installer. The relevant section of Building Regulations only relates to dwellings. Therefore the checklist only applies if the boiler is being installed in a dwelling or some related structure.

Benchmark places responsibilities on both manufacturers and installers. The purpose is to ensure that customers are provided with the correct equipment for their needs, that it is installed, commissioned and serviced in accordance with the manufacturer's instructions by gas safe engineer and that it meets the requirements of the appropriate Building Regulations. The Benchmark Checklist can be used to demonstrate compliance with Building Regulations and should be provided to the customer for future reference.

Installers are required to carry out installation, commissioning and servicing work in accordance with the Benchmark Code of Practice which is available from the Heating and Hotwater Industry Council who manage and promote the scheme.



Visit centralheating.co.uk or installersfirst.co.uk for more information

PRODUCT NAME	PRODUCT CODE	GC NUMBER
CONFEO PREMIX P 14 HM NG ERP YBK UK	8116918110	47-814-15
CONFEO PREMIX P 20 HM NG ERP YBK UK	8116919110	47-814-16
CONFEO PREMIX P 24 HM NG ERP YBK UK	8116920110	47-814-17
CONFEO PREMIX P 28 HM NG ERP YBK UK	8116921110	47-814-18
CONFEO PREMIX P 30 HM NG ERP YBK UK	8116922110	47-814-19
CONFEO PREMIX P 35 HM NG ERP YBK UK	8116923110	47-814-20
CONFEO PREMIX P 14 HCH NG ERP YBK UK	8116933110	41-814-29
CONFEO PREMIX P 20 HCH NG ERP YBK UK	8116937110	41-814-30
CONFEO PREMIX P 24 HCH NG ERP YBK UK	8116924110	41-814-31
CONFEO PREMIX P 28 HCH NG ERP YBK UK	8116925110	41-814-32
CONFEO PREMIX P 30 HCH NG ERP YBK UK	8116926110	41-814-33
CONFEO PREMIX P 35 HCH NG ERP YBK UK	8116927110	41-814-34
CONFEO PREMIX P 14 HST NG ERP YBK UK	8116938110	41-814-35
CONFEO PREMIX P 20 HST NG ERP YBK UK	8116958110	41-814-36
CONFEO PREMIX P 24 HST NG ERP YBK UK	8116928110	41-814-37
CONFEO PREMIX P 28 HST NG ERP YBK UK	8116929110	41-814-38
CONFEO PREMIX P 30 HST NG ERP YBK UK	8116930110	41-814-39
CONFEO PREMIX P 35 HST NG ERP YBK UK	8116932110	41-814-40

Table 1. Product Definition and Codes

INDEX

1- INTRODUCTION.....	5
2- DEFINITION of SYMBOLS.....	6
3- SAFETY RULES AND WARNINGS.....	7
4- REGULATIONS.....	9
5- USEFUL INFORMATION on PRODUCT.....	10
6- PRODUCT INFORM.....	11
6.1- Packaging.....	11
6.2- Main Components and Description.....	14
6.3- Boiler Features.....	17
6.4- Technical Data.....	18
6.5- ERP Technical Data.....	20
6.6- Package Label Calculations.....	21
7- INSTALLATION.....	24
7.1- Selection of Location of Boiler.....	24
7.2- Independent Operation from Ambient Air (Type C).....	25
7.3- Mounting the Boiler.....	25
8- CONNECTIONS.....	26
8.1- Flue Connections.....	26
8.2- Condensate Discharge Connection.....	29
8.3- Gas and Water Connections.....	30
8.4- Electrical Connections.....	30
8.5- Room Thermostat.....	31
8.6- Outdoor Sensor.....	32
8.7- Controller Connections.....	33
8.8- Electrical Connections With Zone Valves.....	34
9- COMISSIONING.....	35
10- USING THE BOILER.....	36
11- CONTROL PANEL.....	36
11.1- Functions of Buttons.....	36
11.2- LCD Screen.....	37
11.3- Operation Functions.....	38
12- GAS CONVERSION.....	39
13- ERROR CODES AND DESCRIPTION.....	40
14- WARRANTY AND SERVICE.....	43
15- ANNEXES.....	47
16- SPARE PART LIST COMISSIONING.....	48
CHECKLIST.....	49
SERVICE RECORD.....	50

1-INTRODUCTION

First of all, we would like to thank you for choosing E.C.A brand. E.C.A. Confeo Premix condensing boilers have been designed to meet for an efficient, safe and comfortable central heating and hot water requirement. The Confeo Premix condensing boilers can possibly use natural gas or LPG according to the desired fuel preference. There is no standard LPG models. LPG usage is only possible after gas conversion in the field.

HM Model (Boiler) : Both Central Heating (CH) and Domestic Hot Water (DHW).

HCH Model (Heat Only) : Only for Central Heating (CH).

HST Model (System Boiler) : Both for Central Heating (CH) and Domestic Hot Water (DHW) with external storage tank (not included).

The assembly and usage information of 14/20/24/28/30/35kW HM-HCH-HST Confeo Premix condensing boilers are available in this manual. Detailed information have been provided in the guide regarding the technical specification of the boiler, selection of the boiler location, fitting its water, gas, flue and electric supply connections, gas conversion, maintenance information and solving of possible failures. Please carefully read the manual in order to benefit from all the features of your boiler.

The Benchmark Checklist and Service Record Card are located at the back of the Operating Manual.



The Benchmark Checklist must be filled by gas safe engineer during installation. Operating Manual and Service Manual must be handed over the user for future operations.

Service Record Card must be filled by gas safe engineer and handed over the user after each service operation and annual maintenance.

1.1 Installer's Responsibility

The installer is responsible for the installation and initial start-up of the boiler. Instructions are given below.

- ✓ Check Operating and Service manuals and follow instructions before installation.
- ✓ Carry out installation in compliance with the prevailing legislation and standards.
- ✓ Be sure that the system is flushed and inhibitor added.
- ✓ Only gas safe engineer must operate the boiler.
- ✓ Explain the user about installation and operation of boiler.
- ✓ Fill the Commissioning Checklist.
- ✓ Give all Operating and Service manuals to user.
- ✓ The warranty certificate must be registered by gas safe engineer within 30 days after installation.

2-DEFINITION OF SYMBOLS







SYMBOL	DEFINITION	SYMBOL	DEFINITION
	Domestic Hot Water	∅	Diameter
	Gas Supply	LPG	Liquid Petroleum Gas
	Parameter Adjustment	DHW	Domestic Hot Water
R	Reset	NTC	Negative Temperature Coefficient (sensor)
	Winter Mode	RCD	Residual Current Device
	Summer Mode	ECV	Emergency Control Valve
	Solar Panel Mode	SEDBUK	Seasonal Efficiency of Domestic Boilers in the United Kingdom
ECO	ECO Mode		
COMFORT	Comfort Mode		

Table 2. Definition of Symbols and Abbreviation



SYMBOL	DEFINITION
	<p>Indicates that the situation that can only be interfered by gas safe engineer.</p>
	<p>Explanation containing information that should be considered by the user.</p>
	<p>CAUTION: It means that you may suffer from material damage or slight personal injury. DANGER: It means that you may suffer from sever personal injury.</p>

Table 3. Definition of Symbols

3-SAFETY RULES AND WARNINGS

3.1 Safety Instructions

When a gas leak is found or suspected;

- ✓ Turn off the gas valve of the boiler and the valves of all other devices operating with gas.
- ✓ Shut off the stove, oven and similar appliances to put their flame out.
- ✓ Do not light matches, lighter etc, and stub out your cigarette.
- ✓ Ventilate the environment by opening doors and windows.
- ✓ Do not ever touch the buttons and plugs of your electrical appliances.
- ✓ Turn off the gas valves in the apartment and building entrance.
- ✓ Do not use the phones at places where the gas leak is suspected.
- ✓ Call your gas safe engineer as soon as possible.
- ✓ Do not place and use flammable and explosive liquid or materials around the boiler.
- ✓ Keep materials such as water, foam away from electrical connections during operations such as cleaning, gas leak test etc.
- ✓ Do not lay the LPG container down
- ✓ Do not block air vents, openings made in the walls of the room which provide fresh air to the installation room.
- ✓ Telephone number of the **National Gas Emergency Service 0800 111 999**

3.2 Water Systems & Gas Supply Line

- ✓ Before installation of the boiler, the water systems (CH & DHW circuit) and gas supply line must be completed in accordance with the relevant regulations and standards by installer.
- ✓ Installation for gas supply pipes must be fitted according to BS6891 for GB and I.S.813.2002 for IE.

3.3 Gas Type Conversion

- ✓ The standard gas type of boiler is Natural Gas. In case of a demanding gas type conversion, this is made with charge.
- ✓ Gas type conversion must be performed by the gas safe engineer. Gas leak test must be made after the conversion operation.
- ✓ Gas conversion label that indicates boiler is converted from NG to LPG must be placed on the boiler after gas type conversion.

3.4 Installation

- ✓ The boiler must be installed in accordance with national and local requirements, gas safety regulations, relevant standards and this manual by gas safe engineer.
- ✓ The boiler must be mounted against a closed wall.
- ✓ The boiler can not be positioned having direct contact to steam, detergent or gases.
- ✓ Any change of flue position must not be made without consulting gas safe engineer.
- ✓ Sunlight can cause color change on the exterior of your boiler over time.
- ✓ The boiler must be installed in indoor spaces under normal conditions. However, it can be operated in a suitable cabinet in places such as garage, open balcony. Please consult E.C.A for proper cabinet sizes.
- ✓ If boiler is located in an unheated area, it must be connected to mains, switched on, and pressure of installation should be within operation range so that freeze protection would be activated. Even if boiler is OFF position, freeze protection stays activated.

3.5 Boiler Start Up

- ✓ Boiler start up must be performed certainly by gas safe engineer.
- ✓ Gas Type (Natural Gas / LPG), gas supply pressure (mbar), maximum DHW operating water pressure (bar) and electricity supply voltage on the information plate must be suitable with mains supply conditions. This is checked by gas safe engineer.
- ✓ After boiler start up, you should request information about operating the boiler and safety precautions from gas safe engineer.

3.6 Usage and Maintenance

- ✓ Read carefully instructions and precautions in this manual against wrong usage which causes unsafe conditions.
- ✓ The boiler should be checked and serviced for general maintenance once a year. Maintenance and service operations must be carried out only gas safe engineer.
- ✓ Only a damp cloth should be used for cleaning the outer surface of the boiler and then the surfaces should be dried completely. Do not use chemical substances or solutions which cause rust and scratches in your boiler.



CAUTION: This boiler is not intended for use by persons (including children) who are low physical or sensory and mental capacity and inexperienced persons without informing and supervising the use of the boiler by responsible persons. Ensure that children under 8 years do not play with the boiler.



CAUTION: If boiler is used incorrectly or for other than its intended use, it may present a life hazard and may cause material damage to the product and its surroundings.



CAUTION: The boiler must be transported and lifted by at least 2 people due to heavy weight.

4-REGULATIONS

Installation regulations

Current Gas Safety (Installation & Use) Regulations:

All gas appliances must be installed by a competent person in accordance with the above regulations.

Failure to install appliances correctly could lead to prosecution.

The appliance must be installed in accordance with, and comply to, the current: Gas Safety Regulations, IET Regulations, Building Regulations, Building Standards (Scotland) (Consolidation), Building Regulations (Northern Ireland), local water by-laws, Health & Safety Document 635 (The Electricity at Work Regulations 1989), EU Regulations No. 811/2013 - Energy Labelling and any other local requirements.

British standards

Where no specific instruction is given, reference should be made to the relevant British Standard codes of Practice.

BS7074:1 Code of practice for domestic and hot water supply

BS1362: Specification for general purpose fuse links for domestic and similar purposes (Primarily for use in plugs)

BS6891 Installation of low pressure gas pipe work up to 28mm (R1)

BS5546 Installation of gas hot water supplies for domestic purposes

EN12828 Central heating for domestic premises

BS5440:1 Flues and ventilation for gas appliances of rated heating not exceeding 70kW (net): Flues

BS5440:2 Flues and ventilation for gas appliances of rated heating not exceeding 70kW (net): Air Supply

BS7593 Treatment of water in domestic hot water central heating systems

BS6798 Installation of gas fired boilers of rated input up to 70kW (net) L.P.G. Installations

An appliance using L.P.G. must not be installed in a room or internal space below ground level unless one side of the building is open to the ground.

Irish Standards

The relevant Irish standards should be followed, including:

- ECTI National rules for electrical installations
- IS 813:2002 for Domestic Gas Installations.

Timber Framed Buildings

Where the boiler is to be fitted to a timber framed building the guidelines laid down in BS5440: Part 1 and IGE "Gas Installations in Timber Frame Buildings" should be adhered to.

Potable Water

All seals, joints and compounds (including flux and solder) and components used as part of the secondary domestic water system must be approved by WRAS.

CH Water

Artificially softened water must not be used to fill the central heating system.

5-USEFUL INFORMATION ON PRODUCT

5.1 Efficient Use of the Combi Boiler in Terms of Safety and Energy Consumption

Isolation of your building is extremely important. Energy saving is achieved to a considerable degree since the heat loss is lowest in houses with double-glazed windows and insulated walls.

- ✓ The use of thermostatic valves in your radiators ensures that the room temperature is constant or allows you to save money.
- ✓ Turning radiator valves lower levels in the rooms which will not be used for a long time and keeping the doors closed keeps fuel consumption low.
- ✓ If you use the program clock with your boiler, the combi boiler operates at the times you set and consumes less fuel.
- ✓ If you use your boiler with room thermostat, it keeps the boiler temperature at the level you set and thus allows less fuel consumption.
- ✓ Covering the radiator top and sides with furniture-like things negatively affects hot air circulation, thus prevents the environment from overheating and increases fuel consumption.
- ✓ If you will leave your boiler in operation late at night, keeping water temperature of the heating circuit at low levels will ensure saving.
- ✓ If you feel that the room temperature is high, the radiator valves should be closed instead of opening windows.

5.2 Clogging in Installation

- ✓ In old installations with iron pipes, usually clogging occurs short time after the boiler is commissioned.
- ✓ If clogging in installation is encountered with, then inhibitor (Sentinel or Fernox etc.) should be added to installation water.
- ✓ For further information visit www.fernox.com or www.sentinel-solutions.net

5.3 Cleaning of Boiler

Keep the outer casing of the combi boiler clean by wiping it with a soft damp cloth. Do not use strong, abrasive cleaning agents.

Performing the maintenance once a year during the warranty period and periodically before the winter season after the warranty expires ensures safe use, saves fuel and extends the useful life of the boiler.

Make sure periodic maintenance is strictly performed by gas safe engineer.

Use original spares parts only to ensure maximum life span and safety of the boiler.

E.C.A will not be responsible for damages to boiler or material or living beings nearby caused by maintenance performed by unauthorized service or staff.

6-PRODUCT INFORMATION

6.1 Packaging



CAUTION: Attention must be paid to warning on packaging regarding handling and storage.

✓ The boiler is delivered with a cartonboard with dimensions of 735 x 345 x 490 (HxWxD) mm, supported by upper and lower styrofoams.

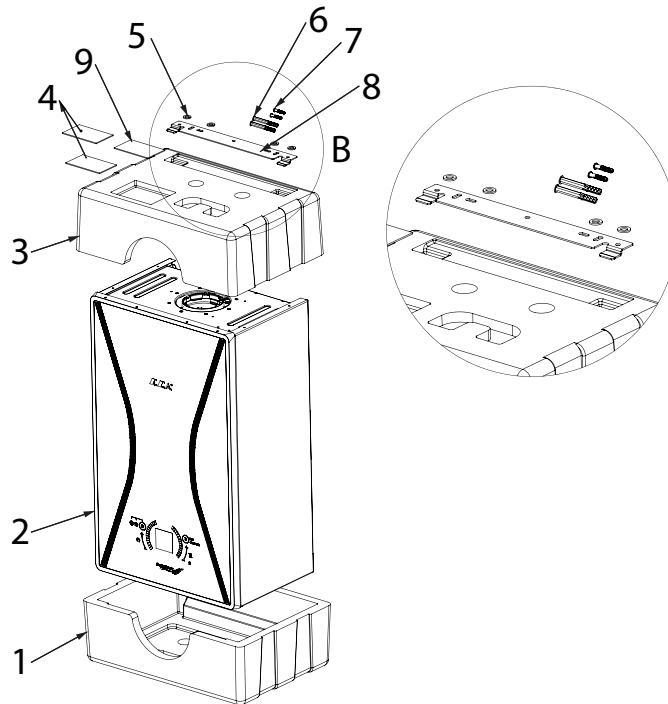

Figure 1. Package Exploded View

STANDARD PACKAGE LIST	
1-3. Bottom-Top Styrofoam	6. Anchors (2 pcs)
2. Boiler	7. Screws (2 pcs)
4. Operating and Service Manuals (2 pcs)	8. Wall Hanging Bracket
5. Gaskets (5 pcs)	9. Wall Mounting Template (1:1)

Table 4. Standard Package List

✓ The hermetic flue set is delivered in a carton box separate from the unit. The standard hermetic flue set (60/100 or Ø 80/125) consists of the following components (Figure 2).

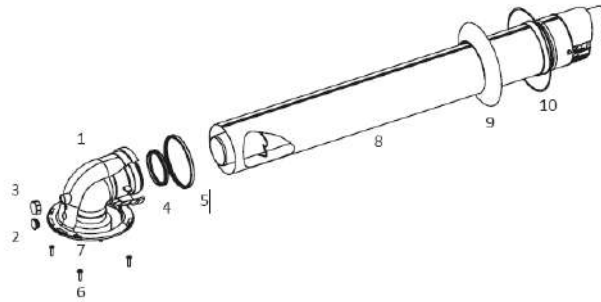

Figure 2. Flue Kit

FLUE PACKAGE LIST	
1. 90° C Elbow	6. Flange Screws
2. Exhaust Gas Tap	7. Flange Gaskets
3. Air Inlet Tap	8. Flue Exhaust Terminal
4. Sealing Gasket Ø60 or Ø80	9. Inner Wall Connection Flange
5. Sealing Gasket Ø 100 or Ø125	10. Outer Wall Connection Flange (EPDM)

Table 5. Flue Package List

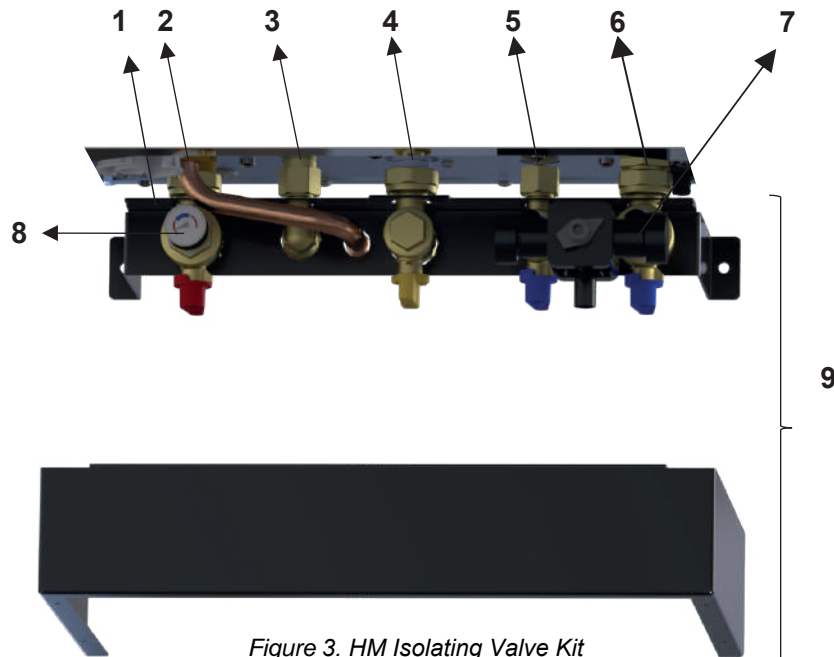

Figure 3. HM Isolating Valve Kit

VALVE KIT PACKAGE LIST	
1. Valve Fixing Bracket (1pc)	6. CH Return Manifold Valve (1pc)
2. CH Supply Manifold Valve (1pc)	7. Wras Approved Filling Loop (1 pc)
3. DHW Outlet Manifold Valve (Elbow) (1pc)	8. Manometer (1pc)
4. Gas Manifold Valve (1pc)	9. Isolating Valve Kit
5. DHW inlet Valve (1pc)	

Table 6. HM Valve Kit Package List

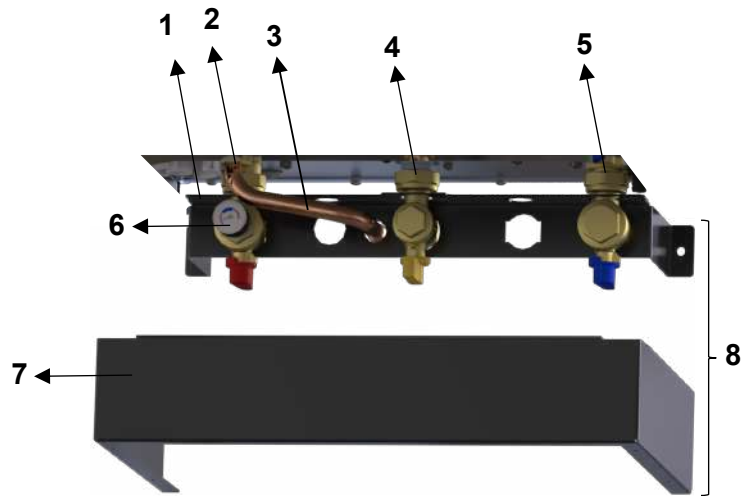

Figure 4. HCH-HST Isolating Valve Kit

VALVE KIT PACKAGE LIST	
1. Valve Fixing Bracket (1pc)	5. CH Return Manifold Valve (1 pc)
2. CH Supply Manifold Valve (1pc)	6. Manometer (1pc)
3. 3 Bar Safety Valve Connection Pipe (1pc)	7. Cover Sheet (1 pc)
4. Gas Manifold Valve (1pc)	8. Isolating Valve Kit

Table 7. HCH- HST Valve Kit Package List

6.2 Main Components and Description

6.2.1 HM Model (Boiler)

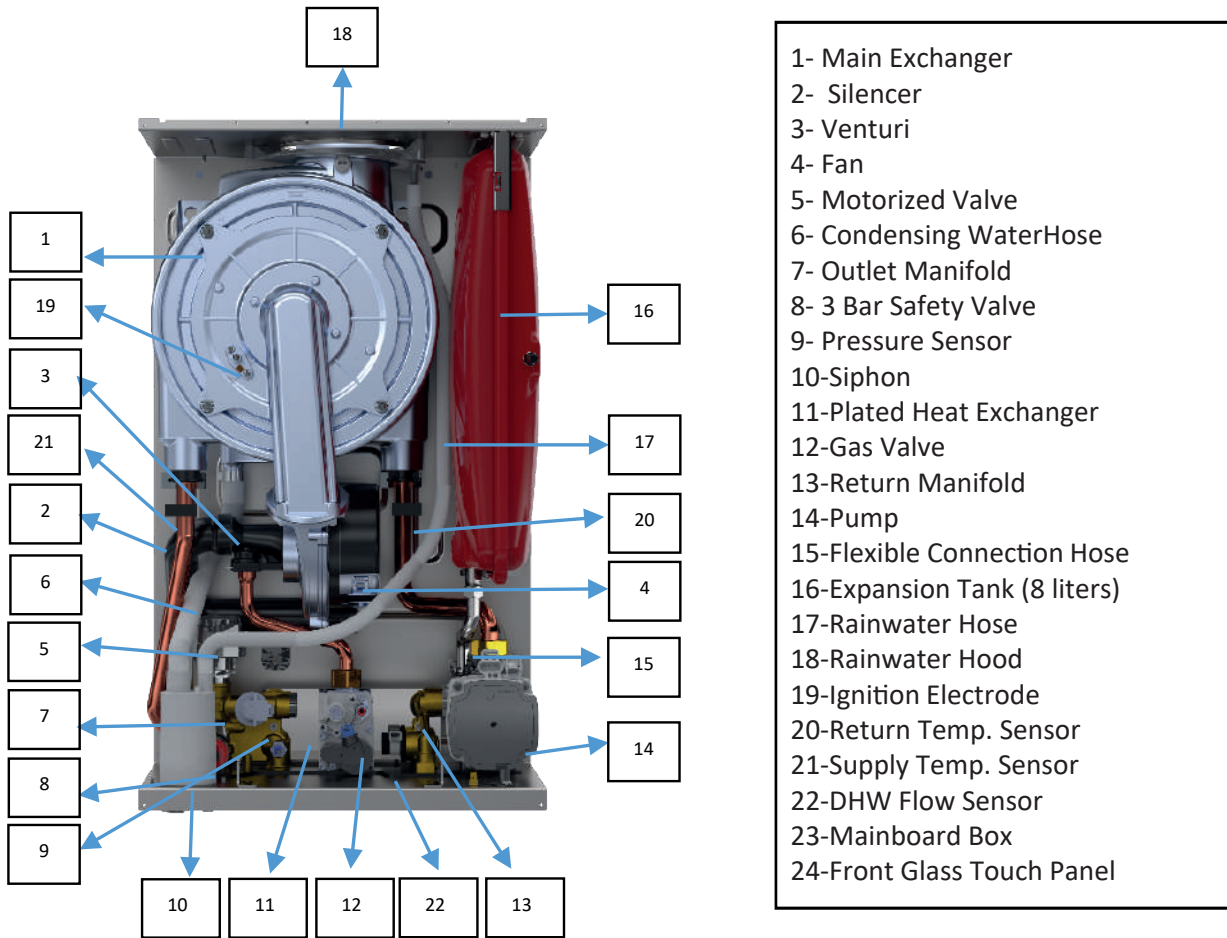
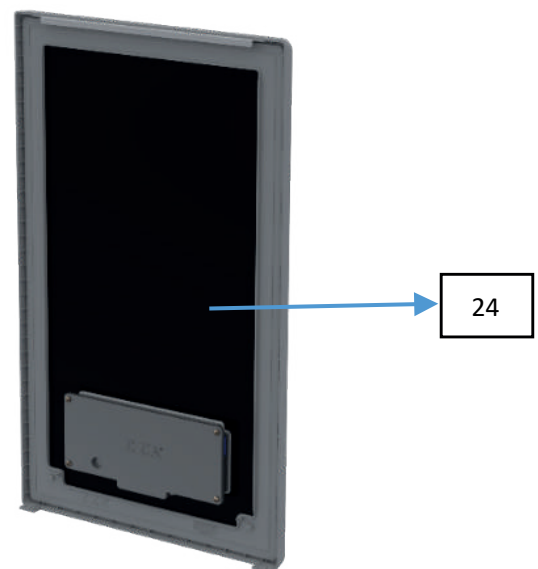
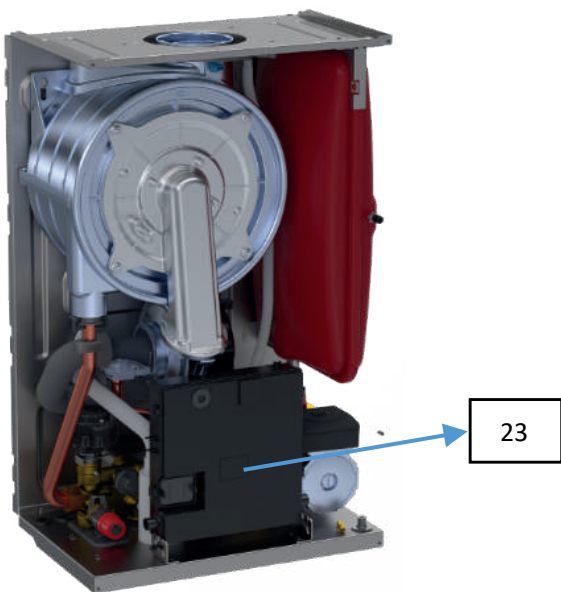

Figure 5. HM Boiler



* Components may be different for some appliance models.

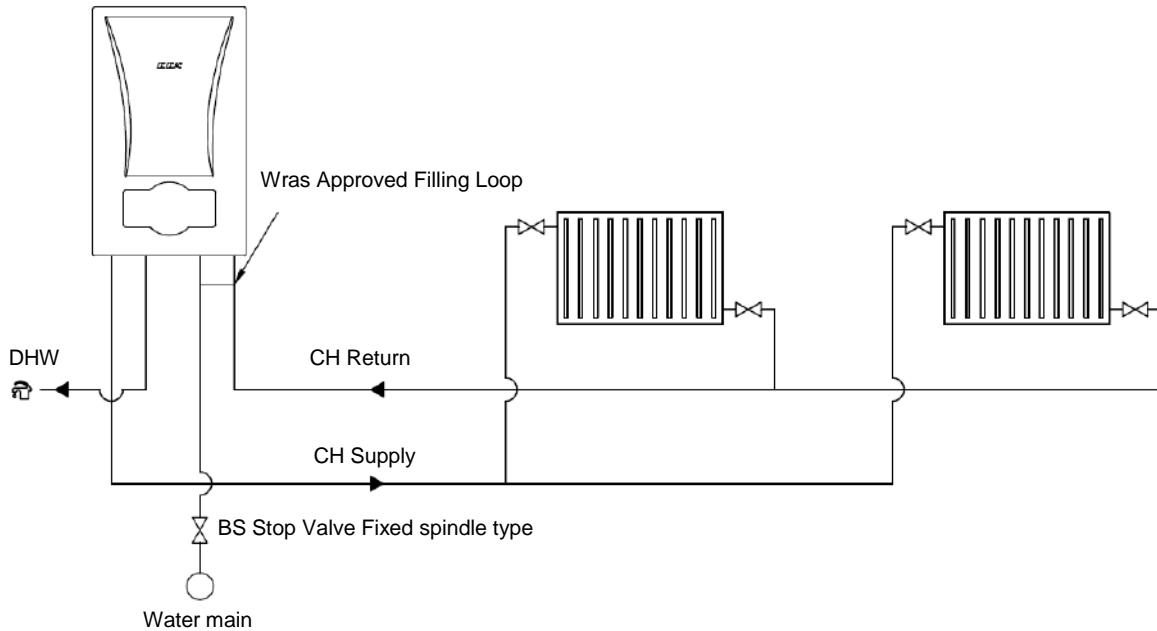

Figure 6. Installation for HM Boiler

6.2.2 HST Model (System Boiler)

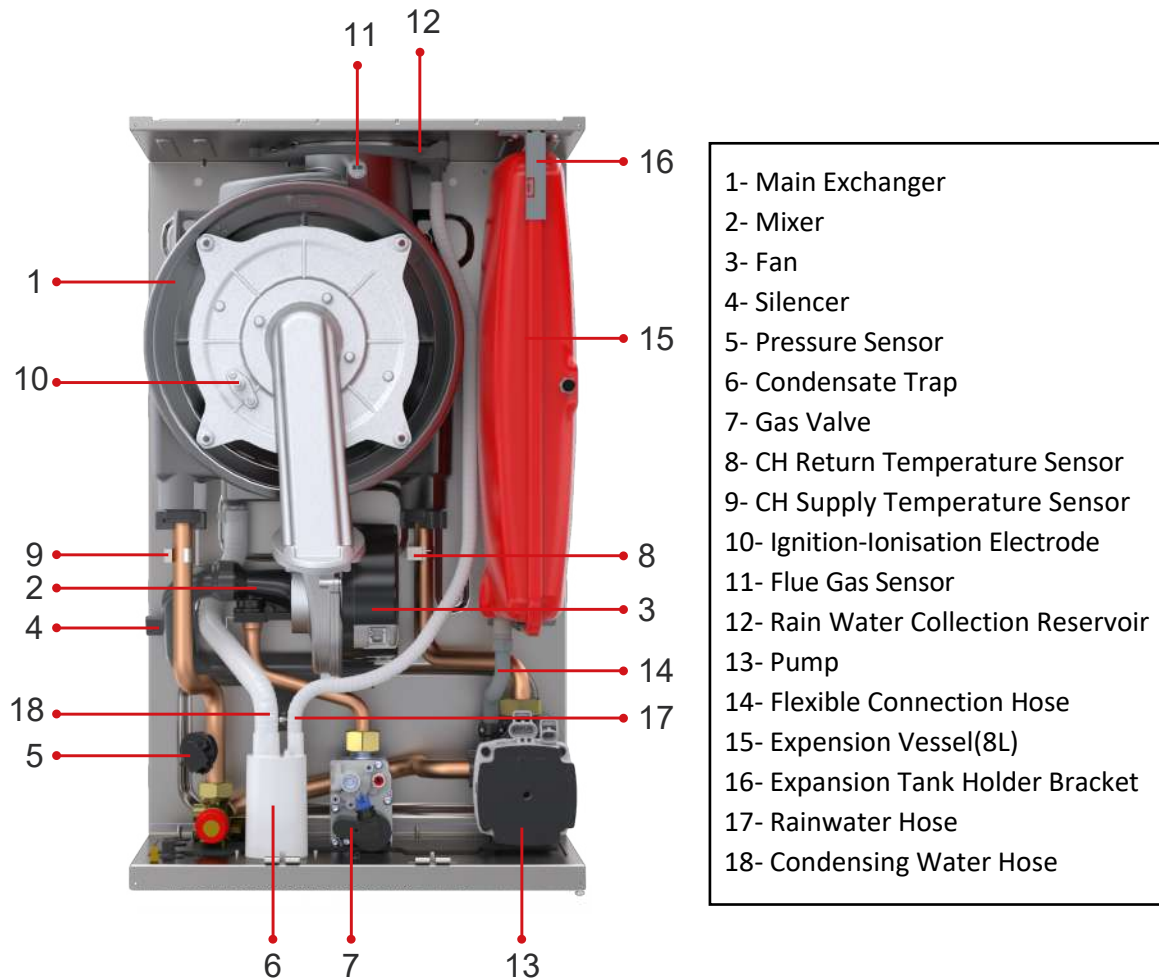

Figure 7. HST Boiler

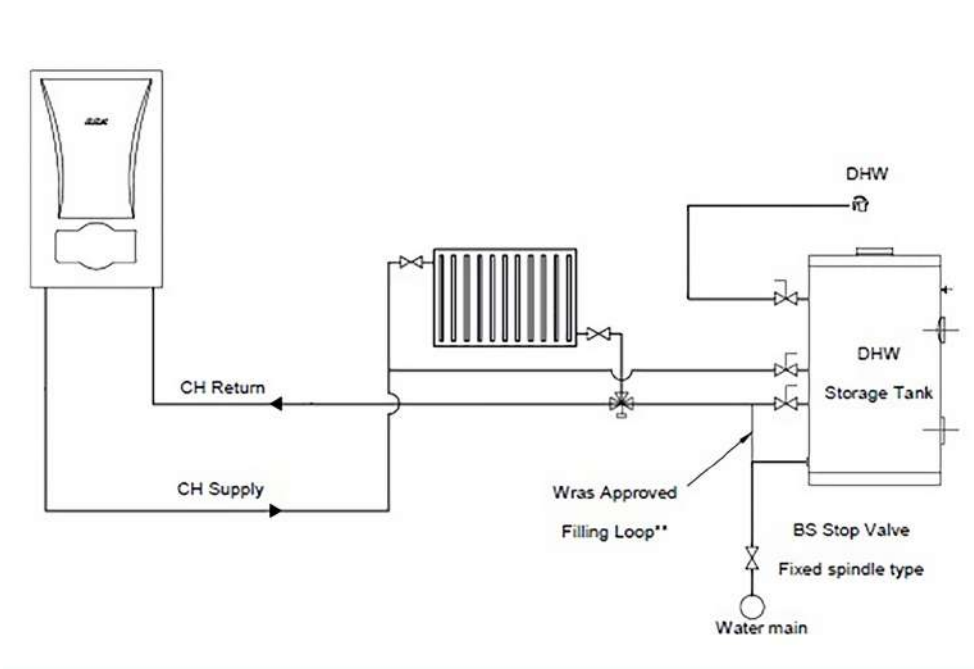

Figure 8. Installation for HST Boiler

****External WRAS approved filling loop must be added during installation.**

6.2.3 HCH Model

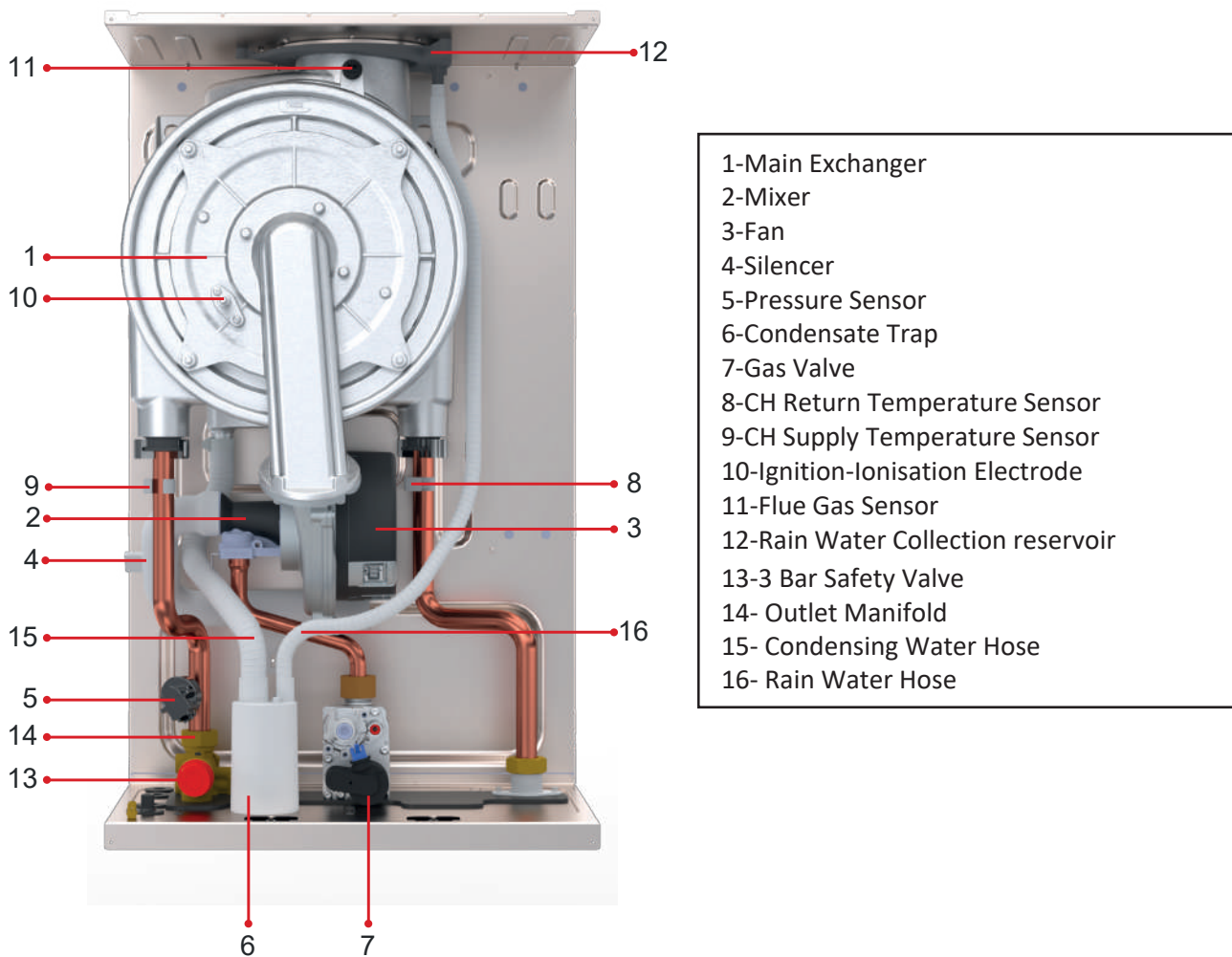

Figure 9. HCH Boiler

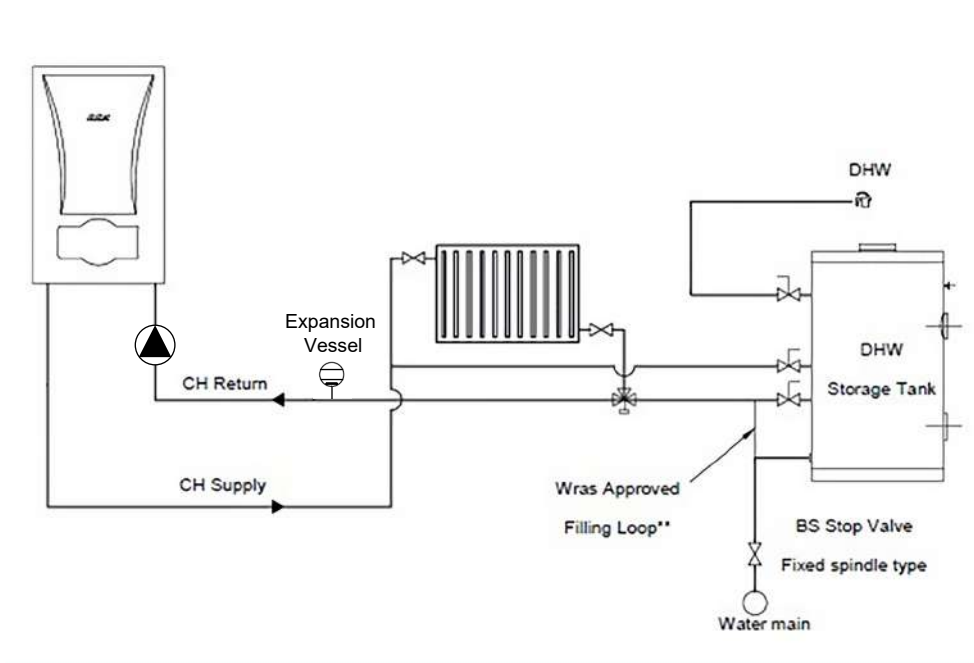

Figure 10. Installation for HCH Boiler (Heat Only Type Installation)

****External WRAS approved filling loop must be added during installation.**

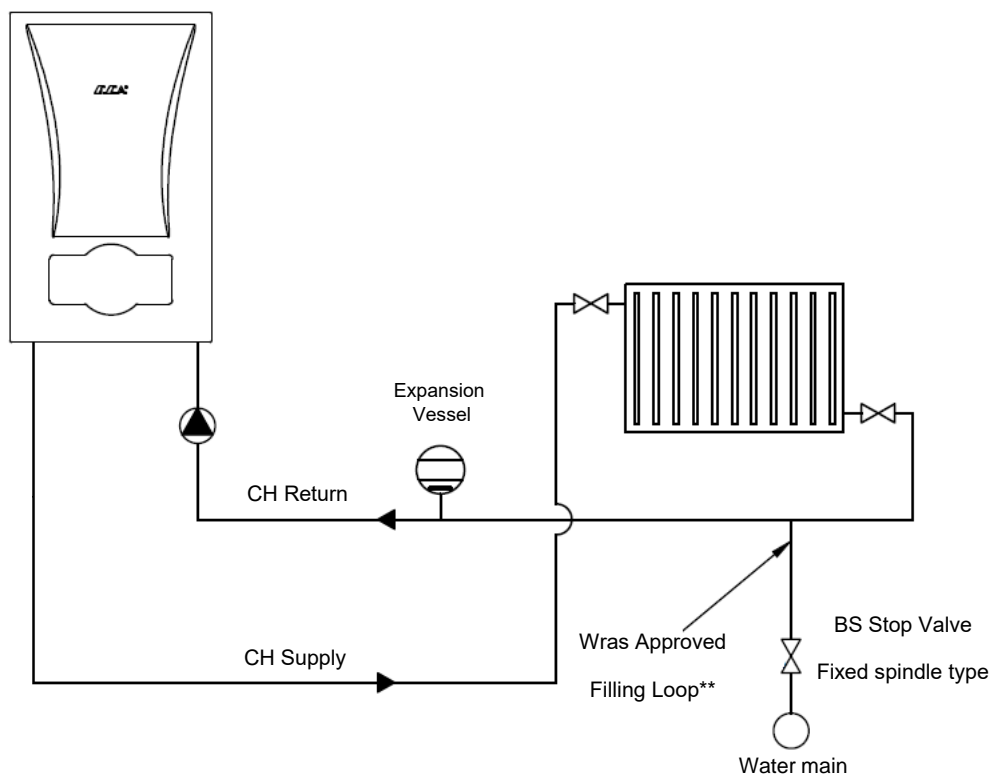

Figure 11. Installation for HCH Boiler (Heat Only Type Installation)

****External WRAS approved filling loop must be added during installation.**

6.3 Boiler Features

Control panel is ergonomic and easy to use. The Confeo Premix condensing boiler with elegant plastic control panel and advanced LCD screen provides ease of use and service. On a LCD display with black instrument panel; you can see the operating state icons, heating circuit and operating water adjustment values, the fault / failure codes and the heating water pressure. With the safety systems available in your boiler, safety of both you and your boiler are fully ensured.

These safety systems are;

- ✓ Flame Failure Safety System
- ✓ Boiler Over-Heat Safety System (95 °C)
- ✓ DHW (Domestic Hot Water) Over-Heat System (71°C)
- ✓ High Water Pressure Protection System (3 bar)
- ✓ Low Water Pressure Protection System (0.4 bar)
- ✓ Low Voltage Protection System (170 VAC)
- ✓ Thermal Accumulation Protection System (with by-pass circuit and "pump over-run")
- ✓ Frost Protection System for both CH and DHW circuit
- ✓ Domestic Hot Water Flow Control (only for HM Model)
- ✓ Pump Anti-sticking Function
- ✓ 3 Way Valve Anti-sticking Function (except HCH - HST Model)
- ✓ Automatic Air Vent
- ✓ Expansion Vessel (8 liters)
- ✓ Water ingress protection from flue
- ✓ Annual Maintenance Reminder
- ✓ Anti-legionella Protection (only for HST Model)
- ✓ Voice Alert System in Case of Error
- ✓ Child Lock
- ✓ Predictive Maintenance Features (In cases where there is a risk of error, giving warning before error occurs)

6.4 Technical Data

Product type	Unit	CONFEO PREMIX P 14 HM-HCH-HST	CONFEO PREMIX P 20 HM-HCH-HST	CONFEO PREMIX P 24 HM-HCH-HST	CONFEO PREMIX P 28 HM-HCH-HST	CONFEO PREMIX P 30 HM-HCH-HST	CONFEO PREMIX P 35 HM-HCH-HST
Gas Category		I2H, I3P, I2Esi, I2E(S), II2L3P, II2H3P, II2ELL3P, II2Esi3P					
Flue Types		C13(X), C33(X), C43(X), C53(X), C63(X), C83(X), B23, B33					
Gas Input Pressure (G20)	mbar	20					
Gas Input Pressure (G31)	mbar	37/50					
Capacity-Efficiency							
CH Min. Heating power - (@60°C min)	kW	5,6	5,6	5,6	6,4	6,9	8
CH Max. Heating power - (@80/60°C) (P4)	kW	14,1	20,2	24,5	28	30	35
CH Min. Heating power - (@30°C min)	kW	6,7	6,7	6,7	7,7	8,3	9,6
CH Max. Heating power- (@50/30°C)	kW	15	22,2	26	29,6	31,7	37
CH Min. Heat input (Qn)	kW	6,2	6,2	6,2	7,2	7,7	9
CH Max. Heat input (Qn)	kW	14,5	20,7	25,2	28,7	30,8	35,9
DHW Max. Heat input (Qn)	kW	25,2	25,2	27,2	31,5	33,5	35,9
Efficiency (@80°/60° C Max) (Gross Calorific value)	%	97,50%	97,50%	97,50%	97,50%	97,50%	97,50%
Efficiency (30°C Return) (Gross Calorific value)	%	107,50%	107,50%	107,50%	107,50%	107,50%	107,50%
ERP Informations							
Seasonal Space Heating Energy Efficiency Class		A	A	A	A	A	A
Water Heating Energy Efficiency Class/ Load Profile		A/XL	A/XL	A/XL	A/XL	A/XL	A/XL
Rated Heat Output (Prated)	kW	14,1	20,2	24,5	28	30	35
Seasonal Space Heating Energy Efficiency	%	92	92,11	92,21	92,71	92,03	92,85
Water Heating Energy Efficiency	%	90,7	90,7	83,6	83,9	82,8	82,8
Sound Power Level	db(A)	44	46	47	49	50	52
Efficiency at Rated Heat Output At High Temperature Regime (η_4)	%	87,9	87,9	87,9	87,9	87,9	87,9
Efficiency at 30% of rated Output At Low Temperature Regime (η_1)	%	97,2	97,2	97,2	97,7	97,5	97,6
At Full Load elmax	kW	0,025	0,035	0,04	0,04	0,056	0,066
At Part Load elmin	kW	0,012	0,012	0,012	0,012	0,013	0,013
In standby Mode	kW	0,004	0,004	0,005	0,004	0,004	0,004
Standby Heat Loss	kW	0,065	0,065	0,065	0,065	0,065	0,065
Emissions of Nox Level (G20)	mg/kWh	33,35	38,06	32,27	21,29	37,4	25,05
Daily Electricity Consumption (Qelect)	kWh	0,2	0,2	0,21	0,22	0,24	0,212
Daily Fuel Consumption (Qfuel)	kWh	23,072	23,072	23,767	22,8	23,021	21,505
Gas Consumption							
Natural Gas (@Min-Max Capacity)	m ³ /h	0,65-1,53	0,65-2,2	0,65-2,65	0,75-3,02	0,81-3,25	0,94-3,79
LPG (@Min-Max Capacity)-Propane	kg/h	0,51-1,2	0,51-1,7	0,51-1,98	0,59-2,26	0,63-2,46	0,74-2,87
NO _x Class		6	6	6	6	6	6
Central Heating							
Min. Water Pressure	bar	0,4	0,4	0,4	0,4	0,4	0,4
Max. Water Pressure	bar	3	3	3	3	3	3
Operation Range (@Radiator heating)	°C	30-80	30-80	30-80	30-80	30-80	30-80
Operation Range (@Underfloor heating)	°C	30-45	30-45	30-45	30-45	30-45	30-45
Max. Limit temperature	°C	> 90	> 90	> 90	> 90	> 90	> 90

Domestic Hot Water (only valid for HM)							
Min. Domestic flow for operating	L/min	2,5 (±%10)	2,5 (±%10)	2,5 (±%10)	2,5 (±%10)	2,5 (±%10)	2,5 (±%10)
Min. Domestic flow for closing	L/min	2,0 (±%10)	2,0 (±%10)	2,0 (±%10)	2,0 (±%10)	2,0 (±%10)	2,0 (±%10)
Max. Domestic hot water flow rate	L/min	10 ±%15 (ΔT = 36,1°C)	10 ±%15 (ΔT = 36,1°C)	12 ±%15 (ΔT = 32,4°C)	12 ±%15 (ΔT = 37,6°C)	12 ±%15 (ΔT = 40,0°C)	14 ±%15 (ΔT = 36,8°C)
Min. Water Pressure	bar	0,4	0,4	0,4	0,4	0,4	0,4
Max. Water Pressure	bar	10	10	10	10	10	10
Operation Range	°C	30-65	30-65	30-65	30-65	30-65	30-65
Max. Limit temperature	°C	≥ 71	≥ 71	≥ 71	≥ 71	≥ 71	≥ 71
General							
Electrical Supply	V AC-Hz	230 VAC-50 Hz					
Electrical consumption (Max-Std Pump)	Watt	120	130	145	155	170	190
Electrical consumption (Only for HCH model)	Watt	26	41	46	71	91	126
Electrical consumption (Max-HE Pump)	Watt	65	80	85	110	130	165
Protection Class		IPX4D					
Expansion Vessel	lt	8					
Weight (Net)	kg	31			32	32	34
Weight (Net) (Only for HCH model)	kg	25			26	26	28
Dimesions (HxWxD)	mm	678*410*288					
Flue Lengths							
C13 – 60/100 Max.	m	10	10	10	10	10	10
C13 – 80/125 Max.	m	20	20	20	20	20	20
C33 – 60/100 Max.	m	10	10	10	10	10	10
C33 – 80/125 Max.	m	20	20	20	20	20	20
C43 – 60/100 Max.	m	10	10	10	10	10	10
C53 – 60/100 Max.	m	10	10	10	10	10	10
C83 – 80/80 Max.	m	28	28	28	28	28	28
C83 – 80/80 Min.	m	3	3	3	3	3	3
B23 – 80 Max.	m	28	28	28	28	28	28
B33- 60/100 Max.	m	10	10	10	10	10	10
Emission Values							
CO ₂ ratio (@max-G20)	%	9,2 ± 0,2	9,2 ± 0,2	9,3 ± 0,2	9,5 ± 0,2	9,5 ± 0,2	9,5 ± 0,2
CO ₂ ratio (@min-G20)	%	8,7 ± 0,2	8,7 ± 0,2	8,7 ± 0,2	8,9 ± 0,2	8,9 ± 0,2	8,9 ± 0,2
CO ₂ ratio (@max-G31)	%	10,4 ± 0,2	10,4 ± 0,2	10,4 ± 0,2	10,6 ± 0,2	10,6 ± 0,2	10,6 ± 0,2
CO ₂ ratio (@min-G31)	%	9,6 ± 0,2	9,6 ± 0,2	9,6 ± 0,2	9,9 ± 0,2	9,9 ± 0,2	9,9 ± 0,2
Boiler Circuit (only valid for HST)							
Operation Range	°C	30-65	30-65	30-65	30-65	30-65	30-65

Table 8. Technical Table

*It's recommended to adjust CH temperature set value above 40°C if you don't use room thermostat.

**It's not recommended to use DHW flow rate below 2,5 l/min for stable DHW usage.

**** It depends on maximum inlet temperature value.

6.5 ERP Technical Data

Confeo Premix P Combi ERP		Units	HM MODEL					
Supplier's name or trademark			E.C.A.					
Supplier's model identifier			Confeo Premix P 14 kW	Confeo Premix P 20 kW	Confeo Premix P 24 kW	Confeo Premix P 28 kW	Confeo Premix P 30 kW	Confeo Premix P 35 kW
Space Heating-Temperature			Medium					
Efficiency Class	Seasonal Space heating		A					
	Water heating		A					
Water heating load profile			XL	XL	XL	XL	XL	XL
Rated heat output (P_{rated})		kW	14,1	20,2	24,5	28	30	35
Annual energy consumption	Space heating	kWh	12267	17574	21315	24360	26100	30450
		GJ	44	63	76	87	94	109
Annual electric consumption	Water heating	kWh	44					
Annual fuel consumption		GJ	18					
Energy efficiency	Seasonal space heating	%	92	92,11	92,21	92,71	92,03	92,85
	Water heating	%	90,7	90,7	83,6	83,9	82,8	82,8
Sound Power Level L_{wa} indoors		dB	44	46	47	49	50	52
Specific precautions for assembly, installation and maintenance			All specific precautions for installation, assembly and maintenance are described in the installation and service manual.					

Confeo Premix P Combi ERP		Units	HCH-HST MODEL					
Supplier's name or trademark			E.C.A.					
Supplier's model identifier			Confeo Premix P 14 kW	Confeo Premix P 20 kW	Confeo Premix P 24 kW	Confeo Premix P 28 kW	Confeo Premix P 30 kW	Confeo Premix P 35 kW
Space Heating-Temperature application			Medium					
Efficiency Class	Seasonal Space heating		A					
Rated heat output (P_{rated})		kW	14,1	20,2	24,5	28	30	35
Annual energy consumption	Space heating	kWh	12267	17574	21315	24360	26100	30450
		GJ	44	63	76	87	94	109
Energy efficiency	Seasonal space heating	%	92	92,11	92,21	92,71	92,03	92,85
Sound Power Level L_{wa} indoors		dB	44	46	47	49	50	52
Specific precautions for assembly, installation and maintenance			All specific precautions for installation, assembly and maintenance are described in the installation and service manual.					

Table 9. ERP Technical Table

6.6 PACKAGE LABEL CALCULATIONS

Package fiche for boilers indicating the space heating energy efficiency of the package

6.6.1 Package Fiche-Boilers

Seasonal space heating energy efficiency of boiler

"T": The value of the seasonal space heating energy efficiency of the preferential space heater, expressed in %.

$$\text{T} \quad \text{①} \quad \%$$

Temperature Control

from fiche of temperature control

Class I = 1%, Class II = 2%, Class III = 1.5%,
Class IV = 2%, Class V = 3%, Class VI = 4%,
Class VII = 3.5%, Class VIII = 5%

$$+ \quad \text{②} \quad \%$$

Supplementary Boiler

Seasonal space heating energy efficiency (in %)

$$\left(\quad - \quad \text{T} \right) \times 0.1 = \pm \quad \text{③} \quad \%$$

Solar Contribution

from fiche of solar device

Collector size (in m²)

Tank Volume (in m³)

Collector efficiency (in %)

Tank rating

A*=0,95, A=0,91,
B=0,86, C=0,83, D -
G =0,81

$$\left(\text{'III'} \times \quad + \quad \text{'IV'} \times \quad \right) \times 0.9 \times \left(\quad / 100 \right) \times \quad = + \quad \text{④} \quad \%$$

"III" : The value of the mathematical expression : $294/(11 \cdot \text{Prated})$, whereby 'Prated' is related to the preferential space heater.

"IV" : The value of the mathematical expression : $115/(11 \cdot \text{Prated})$, whereby 'Prated' is related to the preferential space heater.

(1) If tank rating is above A, use 0.95

Supplementary Heat Pump

from fiche of heat pump

"II" : The factor for weighting the heat output of preferential and supplementary heaters of a package as set out in the following table.

$$\text{Seasonal space heating energy efficiency (in \%)} \\ \text{(} \boxed{} \text{ - 'T') } \times \text{'II'} = \boxed{}^{\textcircled{5}} \%$$

Solar Contribution and Supplementary Heat

Pump select smaller value

$$0,5 \times \boxed{}^{\textcircled{4}} \text{ or } 0,5 \times \boxed{}^{\textcircled{5}} = - \boxed{}^{\textcircled{6}} \%$$

Seasonal Space Heating Energy Efficiency Class of Package

$$\boxed{}^{\textcircled{7}} \%$$

Seasonal Space Heating Energy Efficiency Class of Package

<input type="checkbox"/>	<input type="checkbox"/>	<input type="checkbox"/>	<input type="checkbox"/>	<input type="checkbox"/>	<input type="checkbox"/>	<input type="checkbox"/>	<input type="checkbox"/>	<input type="checkbox"/>	<input type="checkbox"/>
G	F	E	D	C	B	A	A⁺	A⁺⁺	A⁺⁺⁺
<30%	≥30%	≥34%	≥36%	≥75%	≥82%	≥90%	≥98%	≥125%	≥150%

The energy efficiency of the package of products provided for in this fiche may not correspond to its actual energy efficiency once installed in a building, as this efficiency is influenced by further factors such as heat loss in the distribution system and the dimensioning of the products in relation to building size and characteristics.

Package Fiche-Combination Heaters (Boilers or Heat Pumps)

Water heating energy efficiency of combination heater

Declared load profile :

$$\boxed{\text{T } }^{\textcircled{1}} \%$$

Solar Contribution

from fiche of solar device

$$(1.1 \times 'I' - 10\%) \times 'II' - \boxed{\text{Auxillary electricity}} \times 'III' - 'I' = + \boxed{\text{2}} \%$$

Water Heating Energy Efficiency of Package under Average Climate

$$\boxed{\text{3}} \%$$

Water Heating Energy Efficiency Class of Package under Average Climate

		<input type="checkbox"/> G	<input type="checkbox"/> F	<input type="checkbox"/> E	<input type="checkbox"/> D	<input type="checkbox"/> C	<input type="checkbox"/> B	<input type="checkbox"/> A	<input type="checkbox"/> A ⁺	<input type="checkbox"/> A ⁺⁺	<input type="checkbox"/> A ⁺⁺⁺
<input type="checkbox"/> M	<27%	≥27%	≥30%	≥33%	≥36%	≥39%	≥65%	≥100%	≥130%	≥163%	
<input type="checkbox"/> L	<27%	≥27%	≥30%	≥34%	≥37%	≥50%	≥75%	≥115%	≥150%	≥188%	
<input type="checkbox"/> XL	<27%	≥27%	≥30%	≥35%	≥38%	≥55%	≥80%	≥123%	≥160%	≥200%	
<input type="checkbox"/> XXL	<28%	≥28%	≥32%	≥36%	≥40%	≥60%	≥85%	≥131%	≥170%	≥213%	

Water Heating Energy Efficiency under Colder and Warmer Climate Conditions

Colder:

$$\boxed{\text{3}} - 0.2 \times \boxed{\text{2}} = \boxed{\text{3}} \%$$

Warmer:

$$\boxed{\text{3}} + 0.4 \times \boxed{\text{2}} = \boxed{\text{3}} \%$$

The energy efficiency of the package of products provided for in this fiche may not correspond to its actual energy efficiency once installed in a building, as this efficiency is influenced by further factors such as heat loss in the distribution system and the dimensioning of the products in relation to building size and characteristics.

'I' The value of the water heating energy efficiency of the combination heater, expressed in %.

'II' The value of the mathematical expression $(220 \cdot Q_{ref})/Q_{nonsol}$, where Q_{ref} is taken from Regulation EU 811/2013, Annex VII Table 15 and Q_{nonsol} from the product fiche of the solar device for the declared load profile M, L, XL or XXL of the combination heater.

'III' The value of the mathematical expression $(Q_{aux} \cdot 2.5)/(220 \cdot Q_{ref})$, expressed in %, where Q_{aux} is taken from the product fiche of the solar device and Q_{ref} from Regulation EU 811/2013, Annex VII Table 15 for the declared load profile M, L, XL or XXL.

7- INSTALLATION

7.1 Selection of Location of Boiler

The boiler must be installed in accordance with gas safety regulations and relevant standards. Additionally, the clearance around the boiler should be as shown in fig 12. In order to make service, maintenance and usage easier.

Figure 12: It shows the minimum distances required from the top and sides of the boiler (Dimensions given in mm).

The installation must comply with the following minimum distances so that servicing and maintenance of the boiler can be performed correctly. The position of the boiler must be checked against technical requirements.

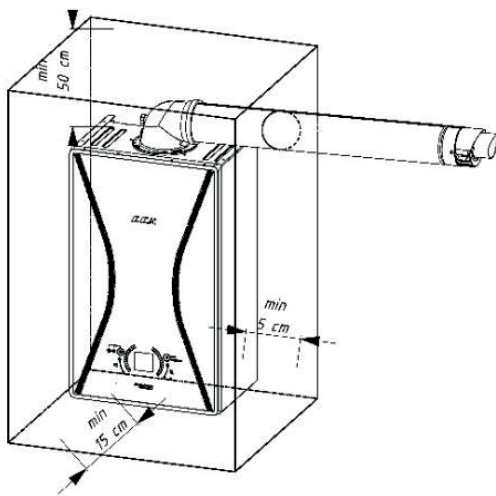

Figure 12. Combi Mounting Clearances

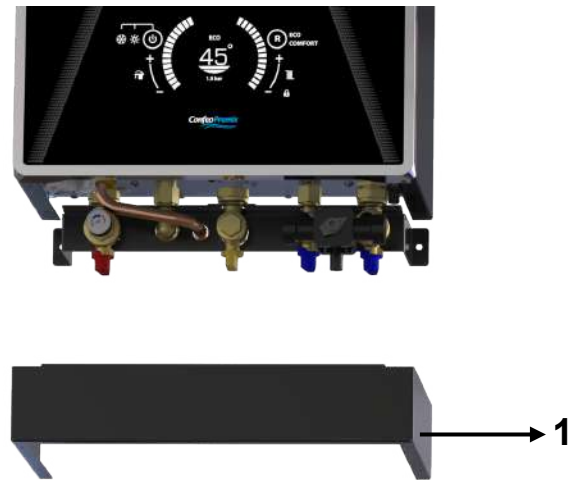

Figure 13. Isolation Valve Cover Mounting

CAUTIONS :



- ✓ Do not install your boilers in locations that will be exposed to direct sunlight. Sunlight can cause color change on the exterior of your boiler over time.
- ✓ Ambient temperature of boiler's installation location should be between 5 -35°C.
- ✓ The boiler can be used at altitudes up to 2000 m above sea level.
- ✓ There is no need to remove side panels in the combi boiler service operations. Minimum 50 mm clearances are given taking into consideration the share of possible side panel sheet changes.
- ✓ Since the outside temperature of the boiler does not rise above 85 ° C at the maximum heating power, no special protective measures are required against the combustible construction materials and components.



- ✓ It is not recommended to install "Isolating Valve Cover" (figure 13-No 1) to the boiler if kitchen cupboard is used for installation place. It can be used at open space areas to hide valve set and filling loop.

7.2 Independent Operation from Ambient Air (Type C)



DANGER: For room sealed operation, the boiler location and air/flue terminal position must obey national and local requirements, gas safety regulations and relevant standards.

- ✓ Type C (hermetic) boilers are not suitable for outdoor installations. These boilers should be installed inside the building.
- ✓ In case of gas leakage, it is necessary to vent the installation room according to national and local requirements, although the room sealed operation boilers are independent of room volume and ventilation.



DANGER: Do not block the air vents, which provide fresh air to the installation room.

- ✓ The air/flue terminal must be exposed to the external air and allow free passage of air cross it at all times.
- ✓ The minimum acceptable dimensions from the terminal to obstructions and ventilation openings must obey national and local requirements.
- ✓ All horizontally fitted ducts (air/flue) should be fitted 2° or 3° upwards incline to allow condensate water drain to the boiler.



- ✓ The flue ducts are always wet.
- ✓ Under cold or excessive humid weather conditions the water vapor inside the waste gas may condensate while leaving the flue.

7.3 Mounting The Boiler

Having determined the boiler location,

- ✓ The points of lock screws of wall bracket and assembly bracket are marked by using the wall-mounting template provided with the boiler.
- ✓ After drilling the marked points, wall assembly bracket and assembly bracket are fixed on the wall by the dowel and lock screws, which are inside the packaging of the boiler.
- ✓ Finally, the boiler is hanged on the wall by placing the assembly bracket on the back side of the boiler on the mounting bracket assembled on the wall.



Figure 14. Boiler & Wall Hanging Bracket

8-CONNECTIONS

8.1 Flue Connections

8.1.1 Flue Sizes

Flue gas connections between the boiler and the flue terminal must be made using original components specially designed for the condensing boiler to ensure that the boiler operates efficiently and correctly.

Flue gas pipes and fittings of non-condensing boilers can not be used for exhausting gases from condensing boilers. In the horizontal concentric flues, the exhaust gas pipe (the inner pipe) facing outwards should be inclined upward and the fresh air pipe (outer pipe) should be inclined downward. When the original flue set is installed parallel to the ground, the exhaust gas pipe is automatically inclined upwards.

Equivalent length for each 90° elbow: 1 m

Equivalent length for each 45° elbow: 0.5 m

8.1.2 Flue Types

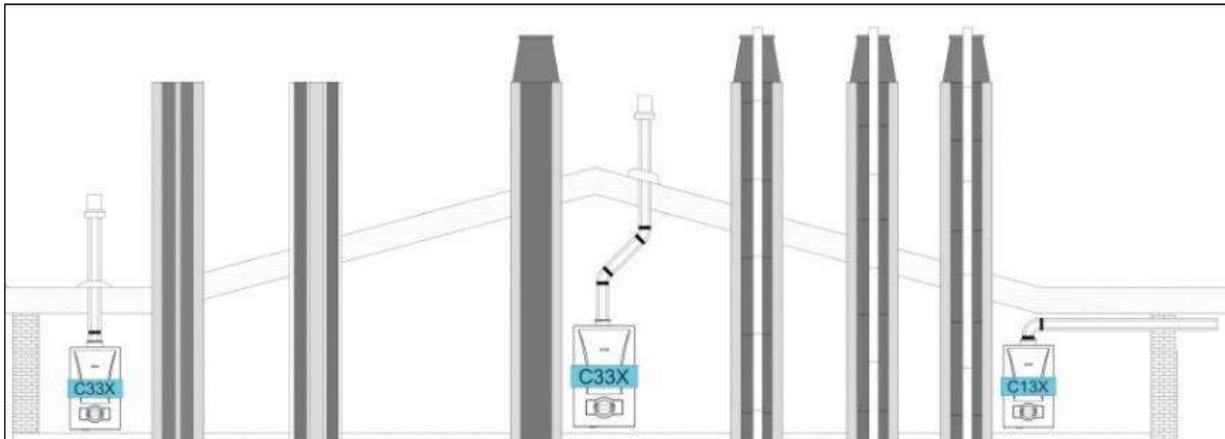

Figure 15. Flue Connections

8.1.3 Plume Management Kit

Standard plume management kit length is 1m. It is an accessory and part code is 7006991251. The minimum distance between nearest window and air inlet side of the flue must be bigger than 150 mm.

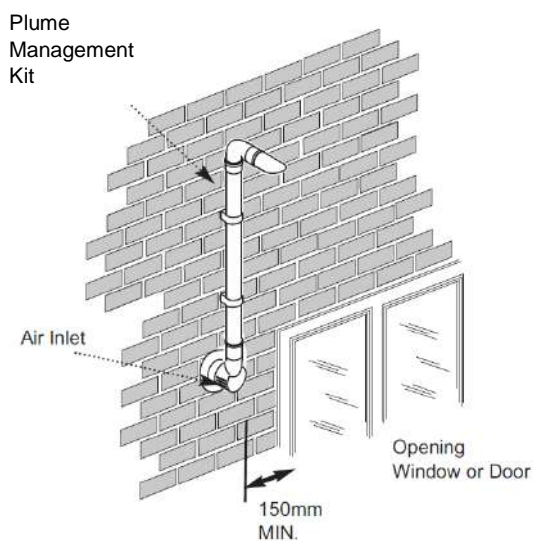
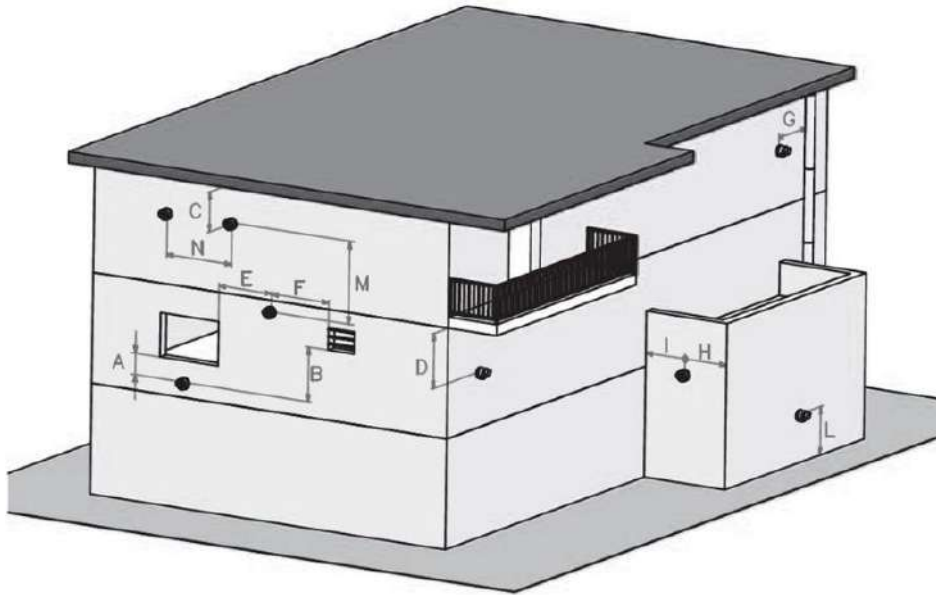

Figure 16. Plume Management Kit

8.1.4 Distances for Placement of Flues



POSITION	DISTANCE (cm)	POSITION	DISTANCE (cm)
A-Below a windows	60	G- Next to vertical or horizontal pipe	60
B- Below an air vent	60	H- Below the distance grille from the outside of the building	30
C- Below rain channel	30	I- Distance from the inner corner of the building	100
D- Under the balcony	30	L- From the ground or from the floor	180
E- Next to a window	40	M- Vertical distance of two flue outlets	150
F- Next to an air grill	60	N- Horizontal distance of two flue outlets	100

Table 10. Flue Connection Information

8.1.5 Flue Sets and Codes











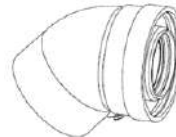



	7006991167 Ø60-100 Flue Set Condensing Elbow 667 Pipe w/ Groove Seam		7006990071 Ø80-125 CCB Extra 45° Elbow
	7006990059 Ø60-100 - 100 cm CCB Insertion and Flue Extension		7006990072 Ø80-125 CCB Vertical Flue Kit
	7006990060 Ø60-100 - 50 cm CCB Insertion and Flue Extension		7006990073 Ø80-125 CCB Flue Adapter
	7006990061 Ø60-100 CCB Insertion 90° Elbow		7006990067 Ø80-125 - 76 cm CCB Horizontal Hermetic Flue Kit
	7006990063 Ø60-100 - 125 cm CCB Vertical Flue Terminal		7006990070 Ø80-125 CCB Extra 90° Elbow
	7006990064 Ø60-100 CCB Vertical Flue Adapter		7006990068 Ø80-125 - 50 cm CCB Additional Flue Extension
	7006990065 Ø60-100 CCB Sloping Roof Adapter		7006990069 Ø80-125-100 cm CCB Additional Flue Extension
	7006990066 Ø60-100 CCB Deck Roof Adapter		7006991251 Ø60/100 CCB Plume Kit

Table 11. Flue Sets

8.2 Condensate Discharge Connection

Information

✓All condensing boilers generate condensate water discharge. The amount of the condensate water depends on the working conditions of your boiler. This can be up to 1.7 litres condensate water an hour.

✓The condensation water must be connected to a drain with the help of a plastic hose which is connected to the end of condensate trap. The use of standard discharge hose is recommended for connection to the drain. The addition of 1 cable connection on the hose should be made for fixing.

✓If drain hose will be connected to drain outside of the building, insulation should be provided to prevent freeze of hose.

✓The condensate discharge hose and interconnection parts must be made of plastic material.

✓All horizontal parts must be connected at least 2,5 ° downwards incline to ensure to a good flow. It can not rise at any point along its length.



✓Condensate discharge must be installed correctly, otherwise operation of the boiler will be affected negatively.

✓It is recommended to make condensate discharge internally into the household drainage system. If it is not possible, needed precaution must be taken to prevent freezing.

✓Ensure the discharge of condensate complies with any national or local regulations (BS 6798).

✓Condensate discharge pipe must be PVC, PVC-U, PVC-C or PP. Metal pipe work is not suitable.

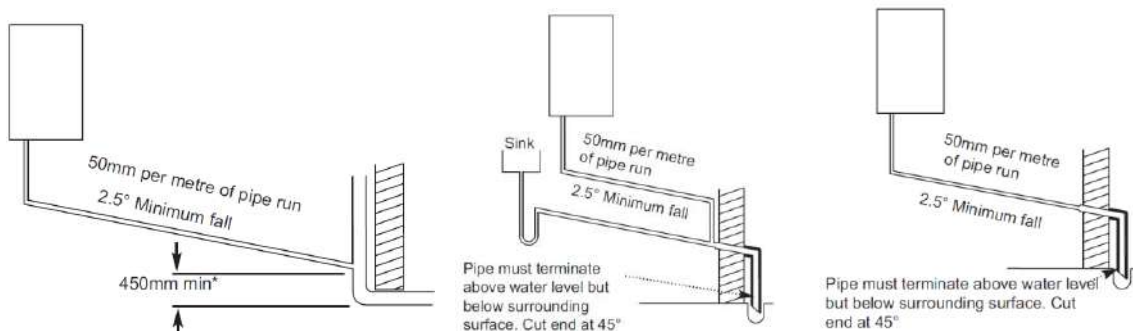

Figure 17. Connection to an internal soil-vent pipe, external termination with sink, to drain or gully

Information

A boiler discharge pump must be used if there is no drain or sink nearby that the condensate can be discharged into. Condensate discharge pump is not standard part of the boiler. Further information must be followed supplied with the pump.

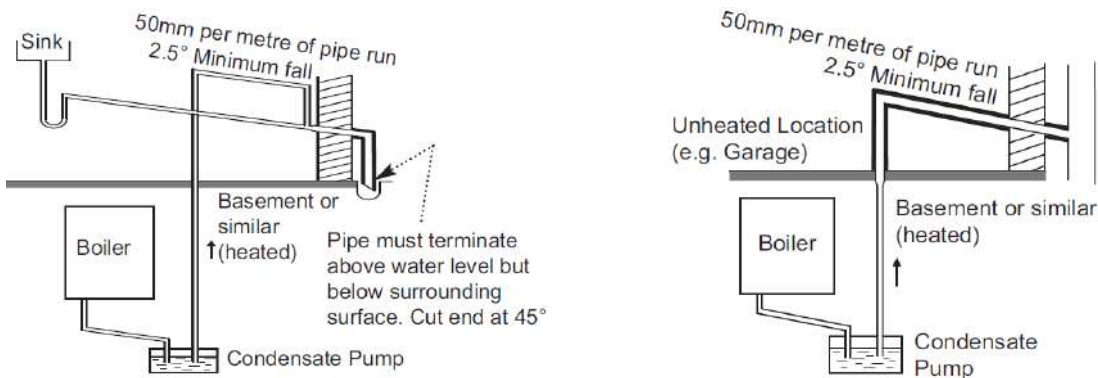
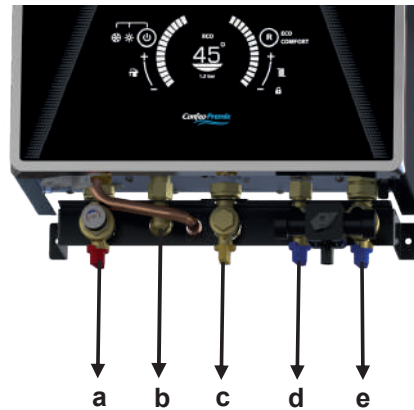

Figure 18. Condensate discharge pump connections

8.3 Gas and Water Connections

8.3.1 HM Model

- a) CH flow $\frac{3}{4}$ " (hot)
- b) DHW outlet $\frac{1}{2}$ " (hot)
- c) Gas inlet $\frac{3}{4}$ "
- d) DHW inlet $\frac{1}{2}$ " (cold)
- e) CH return $\frac{3}{4}$ " (cold)



8.3.2 HCH-HST Model

- a) CH flow $\frac{3}{4}$ " (hot)
- b) Gas inlet $\frac{3}{4}$ "
- c) CH return $\frac{3}{4}$ " (cold)

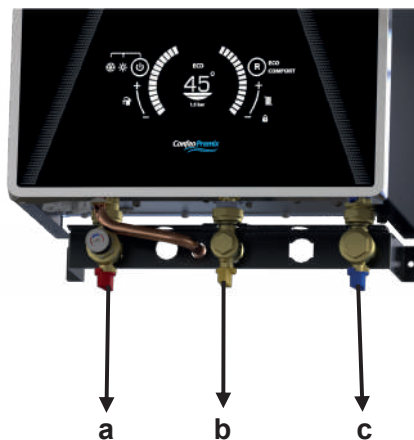

Figure 19. Connections of Boiler

- ✓ Isolating Valve set provided with boiler must be used for water and gas connections.
- ✓ 3 bar safety valve connection must be installed with copper pipe.
- ✓ National and local requirements and legislations must be taken into consideration.

8.4 Electrical Connection

Electrical installation must be made according to the national and local instructions. The boiler must be earthed and a standard 230 V AC – 50 Hz supply is required.



CAUTION: Disconnect power supply to prevent electrical shock before connecting the electrical supply.



CAUTION: If the supply cord is damaged, it must be replaced by the gas safe engineer in order to avoid a hazard.



CAUTION: The ≤ 3 A bipolar fuse (BS 1362) with a minimum contact opening of 3 mm must be used in the electrical connection of the boiler.



CAUTION: The cable diameter (including insulation) of the electrical installation to be installed must be at least 14 mm and the pipe diameter used must be at least 16 mm.

8.5 Room Thermostat

Optional room thermostats compatible with your boiler can be used to control heating system and must be installed by a gas safe engineer.



On/Off Room Thermostat T6360
7006901312



E.C.A. Smart Room
Thermostat Boiler-Air
Conditioning
7006907804



Smart Room Thermostat T6360
7006907531



Digital Room Thermostat DT90
7006902502



Digital Room Thermostat
Wireless/Programmable
7006902046



On/Off Wired Room Thermostat
7006907522

On/Off Wired Room Thermostat
7006907519



Programmable Digital Room Thermostat CM707
7006901313
Wireless
7006901501

Figure 20. Room Thermostat

8.6 Outdoor Sensor

To connect the room thermostat or outdoor sensor to the boiler, the connections behind the control panel are used. For the room thermostat, the bridged cable connection on the back of the control panel is removed and the outer air sensor is connected to free sockets on the terminal.



- ✓ It can be provided as an option according to boiler models.
- ✓ It allows operation of combi boiler adjusted to outside temperature.

Figure 21. Outdoor Sensor

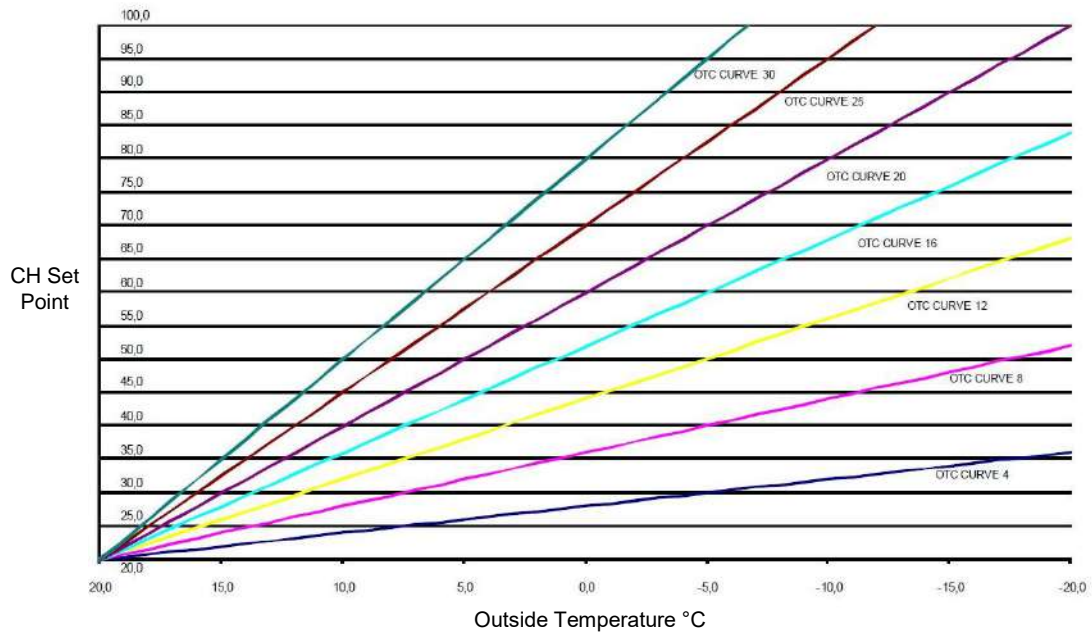

Graph 1. OTC Curve

8.7 Controller Connections

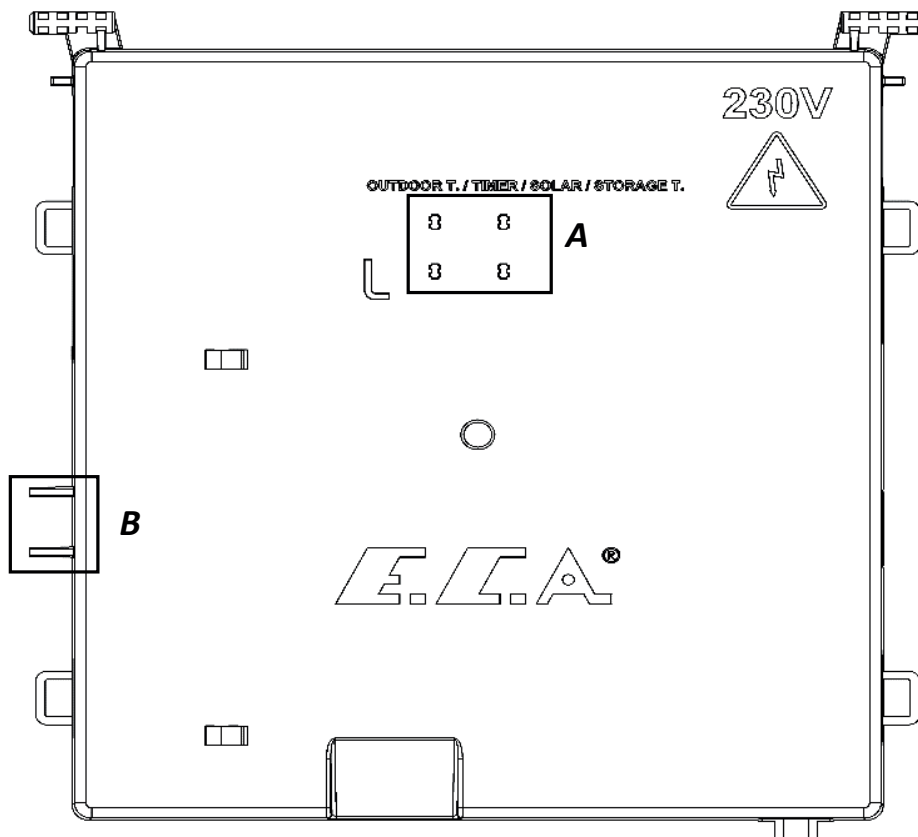
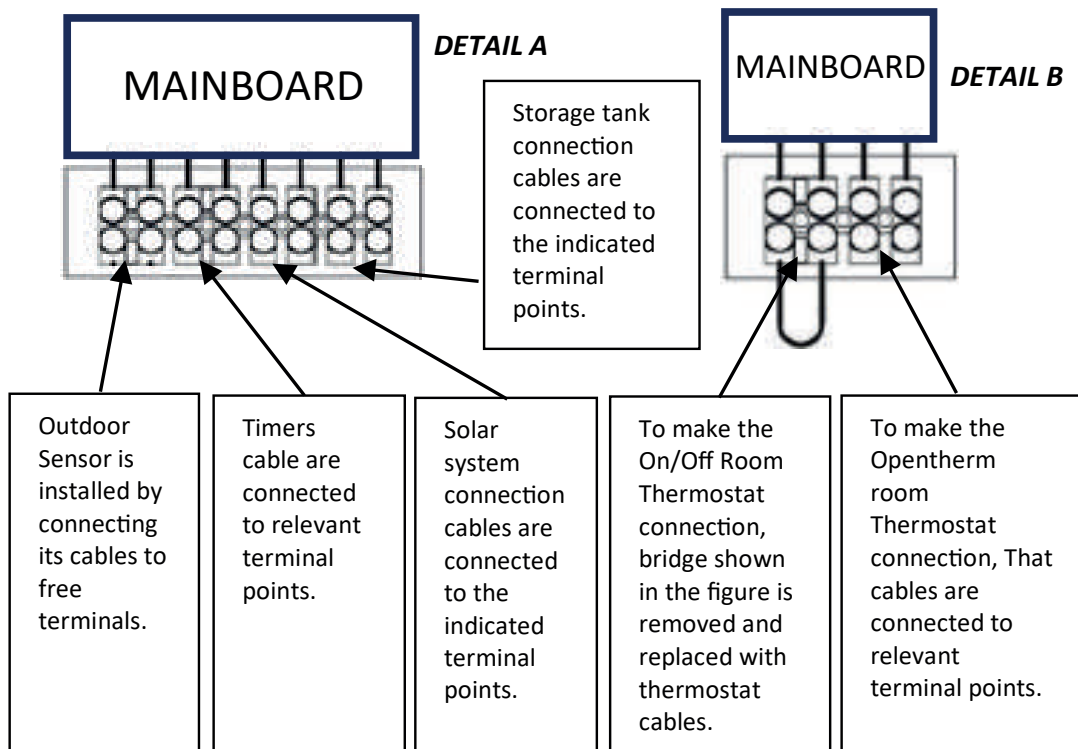

- ✓ Remove the bridge on the other side on room thermostat connection.
- ✓ Gas safe engineer must install the room controller device to boiler.



The connections of room thermostat, outdoor sensor and timer must be performed certainly by gas safe engineer.

8.8 Electrical Connections with Zone Valves

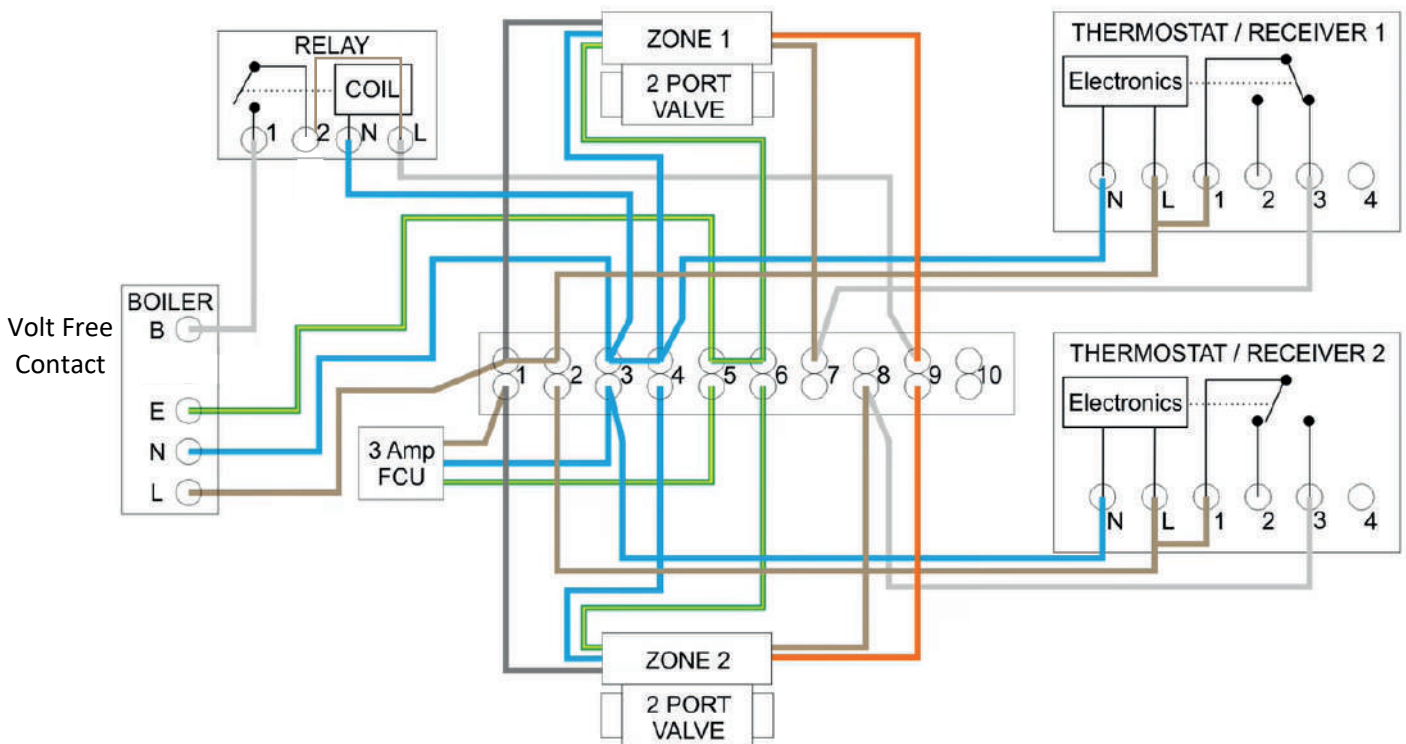
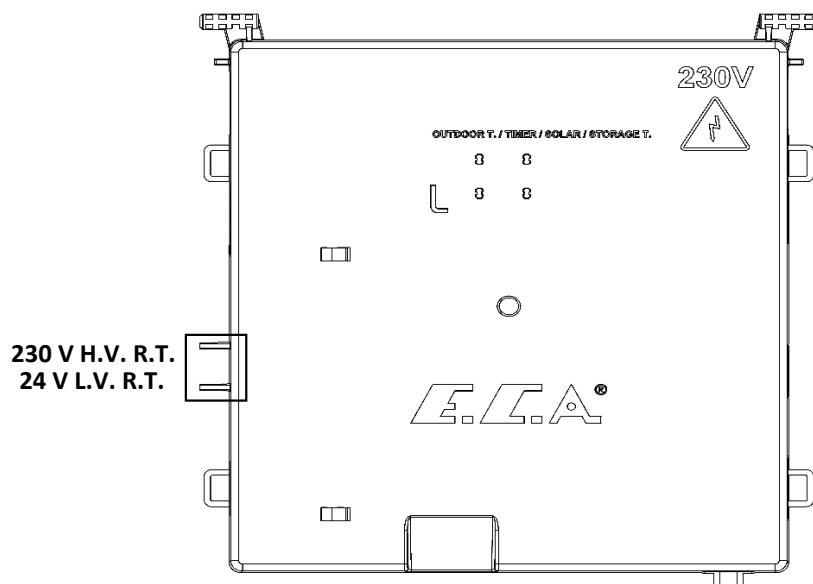

Figure 22. 2 Port Zone Valve

- 1- Remove the front panel.
- 2- Hinge down the control box.
- 3- Remove the link between terminals 1 and 2.
- 4- Use volt free contacts (Room Thermostat contacts) to install a system with zone valves.



CAUTION : Boiler has only volt free contact for switching. Contactor relay switch must be installed according to these indications. There is no 230 V AC input on board.

9- COMISSIONING

9.1 Comissioning, Filling Water into Boiler and Heater Installation

- ✓ First of all, the electrical connection of the boiler is done. The electrical connection of the boiler must be Connected to a grounded power supply line that can supply enough voltage (230 VAC, 50 Hz) for the boiler.
- ✓ All radiator valves should be opened.
- ✓ CH flow and CH return of boiler should be opened. Check them.



ATTENTION: WRAS approved filling loop must be used while filling system.



Figure 23. Filling Loop

- ✓ After all these processes, approved filling valve is slowly opened and filling procedure is initiated. The filling process continues until the water pressure of 1.5-2 bar is seen on the LCD display and then the filling valve is closed.
- ✓ When the water pressure increases to 0.8 bar, the LCD will show "AP" and the boiler will switch to automatic air vent mode. In this case you should definitely wait for 160 seconds without pressing "RESET".
- ✓ Check water pressure on pressure indicator frequently and ensure that the pressure is between 1.5 and 2 bar when system is cold. If the pressure drops frequently, it means that there is a water leak in the system. In such case, it is necessary to call a plumber.



ATTENTION : Always close the water filling valve, the installation water may leak and damage the environment.

- ✓ To discharge air out of CH installation, purgers of the radiator is loosened and air is discharged until water comes out of radiators. This procedure is done for all radiators.
- ✓ Pressure is checked again on LCD screen. The filling valve is opened and again pressure is raised to 1.5 - 2 bar level.
- ✓ Radiator purgers are checked again to see if there is any air left inside of heating installation. For full efficient heating, all air must be discharged.
- ✓ Finally, check for any leaks in the radiator and piping.



ATTENTION: In order to prevent calcification of the heat exchanger, you are advised not to use well water, natural spring water instead of mains water. Check the domestic water installation by opening the hot water tap. Check for any leaks in the piping.



Call gas safe engineer to start up the boiler after all these processes are completed. Commissioning must be strictly performed by authorized service.

✓ At the end of the commissioning of the boiler after installation, please ask for information of gas safe engineer on operating the boiler and relevant safety devices on boiler.

10-USING THE BOILER

10.1 Switching Off the Boiler

You can switch off the boiler by holding down the ON/ OFF button for 3 seconds.

LCD light will be OFF after 1 minute.

Anti-freeze function remains active.

11-CONTROL PANEL

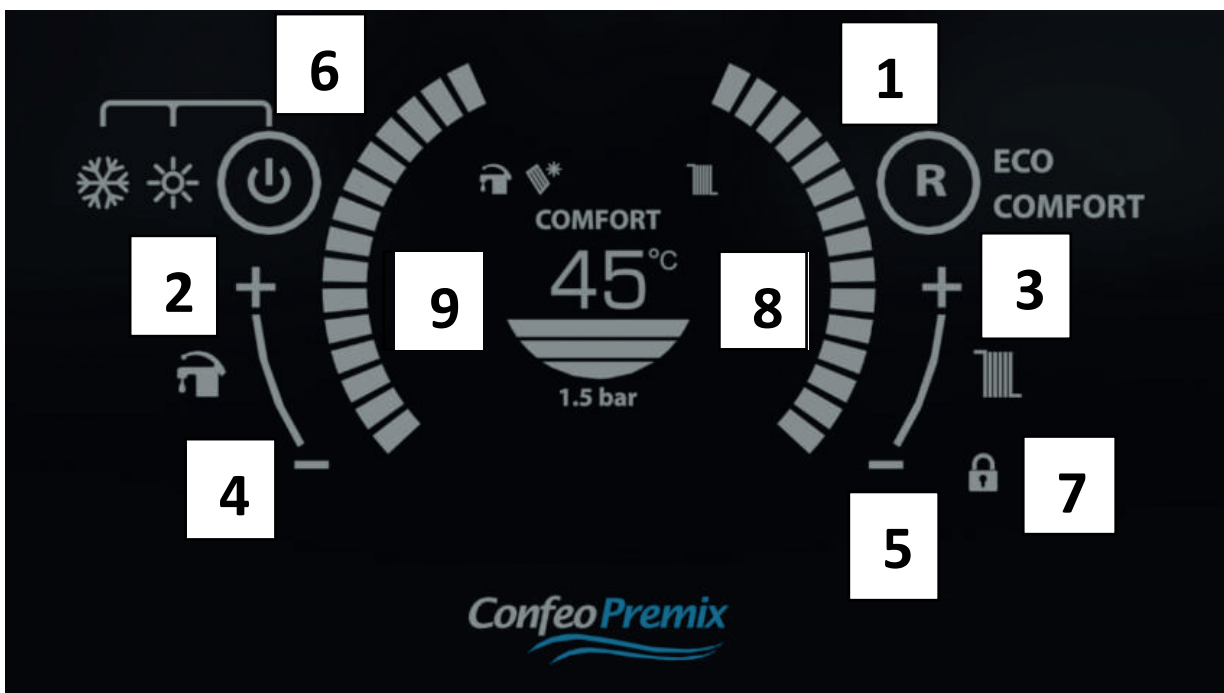

Figure 24 Control Panel View

11.1 Functions of Buttons

The control panel consists of the relevant elements as shown in figure 24 below.

1 Nu. Button: Reset Button Main Functions :

- Exit from lockout error (EXX)
- ECO mode activation
- Comfort mode activation

When your device fails, the error code will start flashing on the display. There are 2 types of errors, lockout (EXX) and blocking (FXX) error. When a lockout error condition occurs (EXX), the error must firstly be corrected so that the error code can be removed from the LCD screen. After pressing the "Reset" key once, the device can switch back to normal operation state. As for a blocking error, the fault cannot be removed from the LCD display pressing the "Reset" button (FXX). When this error is correct-ed, error code is automatically disappears from LCD screen. The first time the device starts, it will start operation in Comfort mode.

Once the Reset button is pressed when operating in Comfort mode, the device will switch to Eco mode. Then when Reset button is pressed again, the unit will switch to Comfort mode.

2 Nu. Button: Domestic Hot Water Increase Temperature Button

The temperature of the domestic water can be increased up to 65 °C thanks to the domestic water temperature increase button.

3 Nu. Button: Central Heating Water Increase Temperature Button

The temperature of the heating water can be increased up to 80 °C thanks to the heating water temperature increase button.

4 Nu. Button: Domestic Hot Water Decrease Temperature Button

The temperature of the domestic water can be decreased down to 30 °C thanks to the domestic water temperature decrease button.

5 Nu. Button: Central Heating Water Decrease Temperature Button

The temperature of the heating water can be decreased down to 30 °C thanks to the heating water temperature decrease button.

6 Nu. Button: Position Selection Button (On/Off and Summer/Winter Switch Button)

Main functions;

The position can be changed by pressing the position selection button once to change between the winter mode and the summer mode. If the button is pressed for 5 seconds, the device will switch into "standby" position. It will suffice to press the button once to get the device in operation position.

7 Nu. Button: Child Lock Button

It is active when the Child Lock Button is kept pressed for 5 seconds and no touch button on the screen performs its function. Just press and hold for 5 seconds to remove it from the child lock.

8 Nu. Button: Central Heating Slider Temperature Button

The temperature of the heating water can be adjusted between 30°C – 80 °C thanks to the central heating slider temperature button.

9 Nu. Button: Domestic Hot Water Slider Temperature Button

The temperature of the domestic water can be adjusted between 30°C – 65 °C thanks to the domestic hot water slider temperature button.

11.2 – LCD Screen

LCD screen display icons described here below.

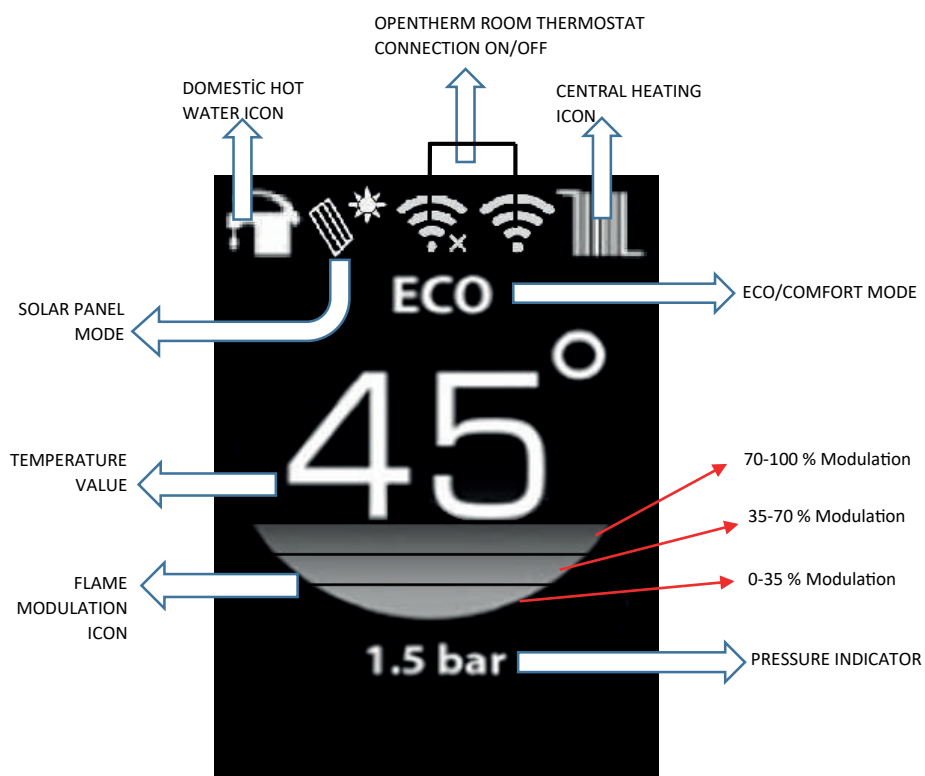

Figure 25. Description of Symbols

11.2.1- Flame Icon

When operating between 0% and 35% capacity range, the icon is displayed on the LCD screen as single bar, whereas it is displayed as two bars when operating between 35% -70% capacity range. If it is displayed as three bars when operating between 70% -100% capacity range.

11.3- Operation Functions

11.3.1- Standby (OFF Mode)

It is the mode in which the device can be placed in standby. When this mode is taken, central heating and domestic water heating demands are not made. To switch to OFF mode, it is necessary to hold the button "6" (position selection button) continuously for 5 seconds.

The mode is activated when the word "OFF" appears on the screen.

11.3.2- Air Discharge Mode (AP Mode)

It is the process that the device applies automatically to discharge the air in the central heating installation for 160 seconds. "AP" appears on the display during this mode. The circulation pump runs for 15 seconds every 20 seconds and stops for 5 seconds. The three-way valve motor also changes positions between CH-DHW every 40 seconds. The situations where this mode is applied are listed below.

- ✓ Once the boiler is powered for the first time or after the electricity has been switched off and on,
- ✓ After the reset operation following the overheating fault (E03),
- ✓ After elimination of high water pressure (F40) or low water pressure (F37) error,



CAUTION: Do not press 'RESET' while AP mode is active.

11.3.3- Winter mode-Radiator Heating: If the boiler in the standby position is set to the winter position, it will heat the water in the heating circuit until the domestic water is needed. In the winter mode, both the tap and the radiator icon are displayed on the LCD screen.

When a request for heating is made for radiator, radiator icon flashes (once/second), tap icon stays fixed. When a request for domestic water is made, tap icon flashes (once/second), radiator icon stays fixed. In this mode, radiator heating circuit's temperature can be set between 30-80 °C. For under floor heating applications, the temperature range can be set between 30-45 °C.

11.3.4- Summer Mode: If the boiler in the OFF position is set to the summer position, the boiler will only respond to the domestic hot water demands. In summer mode, the tap symbol appears fixed on the LCD screen, the radiator icon does not appear. When the domestic hot water is heating request, the tap symbol flashes (1 time/sec). In this mode, the domestic hot water temperature can be adjusted between 30-65 °C.

11.3.5- Comfort Mode: The standard operating mode of the boiler is Comfort mode. By pressing the "Reset" button, Eco-Comfort modes can be switched. When Comfort mode is active, "Comfort" icon is displayed on the LCD screen. Comfort mode is only for radiator heating circuit. It has no effect on use of domestic water circuit. In this mode, the boiler responds to fast heating demands by running in modulation.

11.3.6- ECO Mode: By pressing the "Reset" button, Eco-Comfort modes can be switched. When Eco mode is active, "Eco" icon is displayed on the LCD screen. Eco mode is only for radiator heating circuit. It has no effect on use of domestic water circuit. This mode allows savings on fuel by performing on-off operation.



11.3.7- Annual Maintenance Reminder: This mode reminds user that “annual maintenance time is very soon”. When this mode is active, only "ASE" is displayed on screen and boiler continues to meet heating requests. Electrical connection of boiler must be always connected to mains, otherwise function will not work properly. When you see "ASE" on screen, please check your boiler start up date and contact with gas safe engineer if annual maintenance period is arrived. If maintenance of the boiler is done before “ASE” appears on screen, you can skip it by pressing “R” button.

11.3.8- Anti-Frost Mode: During the winter season, when the installation water temperature falls below 6 ° C, the anti-freeze function is activated and the boiler continues to operate until the water output of installation rises to 15 ° C. In order for anti-freeze function to be activated, the following conditions must be checked and ensured by the customer.

- ✓ The power supply of the boiler must be switched on.
- ✓ The gas valve and radiator valves must be open.
- ✓ Water pressure of system should be at appropriate level.
- ✓ The anti-freeze function helps protect your boiler, it does not protect your installation.
- ✓ If the boiler will not be operated for a while in places where there is risk of freezing, then it is necessary to drain the water or to use an anti-freeze agent

12-GAS CONVERSION



Gas conversion operation from natural gas to LPG must be performed by gas safe engineer. If the user requests gas transformation after purchase of the boiler, it is subject to a fee.

For the gas conversion process, a conversion kit is required. The conversion kit includes 1 gas orifice, 1 gasket and 1 gas conversion label. Procedure for gas conversion is;

- ✓ Installation of parts in the conversion kit
- ✓ Gas adjustment
- ✓ Parameter change (P01: 0 for natural gas, P01:1 for LPG)

➤ GAS SETTING CHART

Capacity	Gas Type	Gas Orifice (mm)	Gas Orifice Code	P01 Parameter Value	DHW Maximum Fan Speed (rpm)	CH Maximum Fan Speed (rpm)	Minimum Fan Speed (rpm)	Front Cover (Open) CO2 (Max/Min) (%)	Front Cover (Close) CO2 (Max/Min) (%)	P39 Parameter Value
14 kW	DG	7,65±0,05	7006990320	0	6250	3800	1850	9,3±0,2 / 8,7±0,2	9,5±0,2 / 8,9±0,2	0
14 kW	LPG	6,5±0,05	7006990685	1	6100	3600	1850	10,4±0,2 / 9,7±0,2	10,6±0,2 / 9,9±0,2	0
20 kW	DG	7,65±0,05	7006990320	0	6250	5100	1850	9,3±0,2 / 8,7±0,2	9,5±0,2 / 8,9±0,2	0
20 kW	LPG	6,5±0,05	7006990685	1	6100	4900	1850	10,4±0,2 / 9,7±0,2	10,6±0,2 / 9,9±0,2	0
24 kW	DG	7,65±0,05	7006990320	0	6750	6250	1850	9,3±0,2 / 8,7±0,2	9,5±0,2 / 8,9±0,2	0
24 kW	LPG	6,5±0,05	7006990685	1	6600	6100	1850	10,4±0,2 / 9,7±0,2	10,6±0,2 / 9,9±0,2	0
28 kW	DG	7,9±0,05	7006990688	0	7000	6500	1900	9,3±0,2 / 8,7±0,2	9,5±0,2 / 8,9±0,2	2
28 kW	LPG	6,7±0,05	7006990689	1	6700	6200	1900	10,4±0,2 / 9,7±0,2	10,6±0,2 / 9,9±0,2	2
30 kW	DG	7,9±0,05	7006990688	0	7450	6900	2100	9,3±0,2 / 8,7±0,2	9,5±0,2 / 8,9±0,2	4
30 kW	LPG	7,1±0,05	7006990691	1	7400	6850	2100	10,4±0,2 / 9,7±0,2	10,6±0,2 / 9,9±0,2	4
35 kW	DG	8,1±0,05	7006990690	0	7600	7600	2300	9,3±0,2 / 8,7±0,2	9,5±0,2 / 8,9±0,2	6
35 kW	LPG	7,1±0,05	7006990691	1	7600	7600	2300	10,4±0,2 / 9,7±0,2	10,6±0,2 / 9,9±0,2	6

Table 12. Gas Setting Table

13-ERROR CODES AND DESCRIPTION

Error Code	Error Type	Possible Cause	Troubleshooting
E01	Ignition Fault	No gas connection for combi boiler.	<ol style="list-style-type: none"> 1- Check that the gas valve is open. 2-Check if there is gas in installation. 3- Press reset button. 4- If the error is still present (or persists) after reset, notify authorized service of E.C.A.
E02	False Flame Signal	It is triggered if flame is detected in the burner while gas valve is closed.	<ol style="list-style-type: none"> 1- Press reset button. 2- If the error is still present (or persists) after reset, notify authorized service of E.C.A.
E03	Over Temperature Warning	It will occur if the temperature of return and supply water exceeds 90 C.	<ol style="list-style-type: none"> 1- Check that water valves of boiler installation are open. 2- If the combi boiler triggers this error in winter mode, check that at least 1 radiator is open. 3- Press reset button. 4- If the error is still present (or persists) after reset, notify authorized service of E.C.A.
E15	Measurement deviation fault of temperature sensors	Temperature sensors might be defective.	<ol style="list-style-type: none"> 1- Press reset button. 2- If the error is still present (or persists) after reset, notify authorized service of E.C.A.
E16	Error on Temperature Sensor for Supply Water	No temperature is detected by temperature sensor for supply water.	<ol style="list-style-type: none"> 1- Press reset button. 2- If the error is still present (or persists) after reset, notify authorized service of E.C.A.
E17	Error on Temperature Sensor for Return Sensor	No temperature is detected by temperature sensor for return sensor.	<ol style="list-style-type: none"> 1- Press reset button. 2- If the error is still present (or persists) after reset, notify authorized service of E.C.A.
E18	Temperature Sensor Error	The temperature change on the temperature sensor is too high (> 30 C)	<ol style="list-style-type: none"> 1- Press reset button. 2- If the error is still present (or persists) after reset, notify authorized service of E.C.A.
E33	Error on Temperature Sensor for Return Sensor	The return water temperature sensor is in short or open circuit state.	<ol style="list-style-type: none"> 1- Press reset button. 2- If the error is still present (or persists) after reset, notify authorized service of E.C.A.
E35	Error on Temperature Sensor for Supply Water Temperature	The outgoing water temperature sensor is in short or open circuit state.	<ol style="list-style-type: none"> 1- Press reset button. 2- If the error is still present (or persists) after reset, notify authorized service of E.C.A.
E38	Low water pressure error 1 week after last water filling	Water leakage in plumbing or boiler	<ol style="list-style-type: none"> 1- Press reset button. 2- If the error is still present (or persists) after reset, notify authorized service of E.C.A.
E44	Valve provides no feedback	The gas valve may be failed.	<ol style="list-style-type: none"> 1- Press reset button. 2- If the error is still present (or persists) after reset, notify authorized service of E.C.A.
E64	Hardware Faults 1	Specific fault in hardware	<ol style="list-style-type: none"> 1- Switch off and on the boiler. 2- If the error is still present (or persists) after switch off/on, notify authorized service of E.C.A.

E65	Hardware Faults 2	Specific fault in hardware	1- Switch off and on the boiler. 2- If the error is still present (or persists) after switch off/on, notify authorized service of E.C.A.
E80	Temperature difference error between return water temperature and supply water temperature sensor	Temperature detected by temperature sensor for return water is higher than temperature detected by temperature sensor for supply sensor	1- Press reset button. 2- If the error is still present (or persists) after reset, notify authorized service of E.C.A.
E82	Flame failure (more than 12 flame loss in one hour)	Flame detection problem	1- Press reset button. 2- If the error is still present (or persists) after reset, notify authorized service of E.C.A.
E83	High Temperature Error for Flue Gas (twice F07 error in last month)	Main Exchanger problem	1- Press reset button. 2- If the error is still present (or persists) after reset, notify authorized service of E.C.A.
E98	Hardware Faults 3	Specific fault in hardware	1- Switch off and on the boiler. 2- If the error is still present (or persists) after switch off/on, notify authorized service of E.C.A.
E99	Hardware Faults 4	Specific fault in hardware	1- Switch off and on the boiler. 2- If the error is still present (or persists) after switch off/on, notify authorized service of E.C.A.
F05	Fan Feedback Fault	Failure of fan or fan cable	1- Press reset button. 2- If the error is still present (or persists) after reset, notify authorized service of E.C.A.
F07	Over Temperature Error for Flue Gas	It occurs when the temperature of the flue gas exceeds 95 °C.	1- Notify authorized service of E.C.A.
F10	Insufficient water circulation error	Clogging in installation	1- Notify authorized service of E.C.A.
F13	Repeated Reset Fault	Pressing of Reset button more than 5 times in an hour	1- Notify authorized service of E.C.A.
F34	Low Supply voltage	It occurs when the supply voltage falls below 170V.	1- Notify authorized service of E.C.A.
F36	Main Frequency Fault	Main (electricity) problem	1- Notify authorized service of E.C.A.
F37	Low Water Pressure Fault	It occurs when water pressure sensor detects a relatively low water pressure (0.4 bar) for your device.	1- Check water pressure in heater installation of your device. 2- Fill the system with water until the pressure reaches 1.5-2 bar (device will eliminate error when the pressure is over 0,8 bar). 3-Check your valves and installation against leaks. 4- If the problem is still present (or persists), notify authorized service of E.C.A.
F39	Outdoor Temperature Sensor Fault	Outdoor temperature sensor might be defective.	1- Press reset button. 2- If the error is still present (or persists) after reset, notify authorized service of E.C.A.

F40	High Water Pressure Fault	It occurs when water pressure sensor detects a relatively high water pressure (2,9 bar) for your device.	1- Check water pressure in heater installation of your device. 2- Tur off the device and restart it. 3- If the error is still present (or persists) after reset, notify authorized service of E.C.A.
F41	Water Filling (Auto) Running	Automatic water willing is continuing	1- Notify authorized service of E.C.A.
F42	Water Fillin (Auto) Not Completed	Water filling valve may be failed or mains water pressure may be insufficient.	1- Notify authorized service of E.C.A.
F43	Low Water Pressure After Auto Water Filling Fault	Water filling valve may be failed or mains water pressure may be insufficient.	1- Notify authorized service of E.C.A.
F47	Water Pressure Sensor Error	Water pressure sensor is not plugged in or there is no contact.	1- Press reset button. 2- If the error is still present (or persists) after reset, notify authorized service of E.C.A.
F49	Modulation Room Thermostat Communication Fault	Room Thermostat may be failed or connection problem	1-Switch off and on the boiler. 2- Press reset button. 3- If the error is still present (or persists) after reset, notify authorized service of E.C.A.
F50	Storage Tank Sensor Fault	Storage tank sensor might be defective.	1- Press reset button. 2- If the error is still present (or persists) after reset, notify authorized service of E.C.A.
F51	PT1000 solar sensor error	PT1000 solar sensor might be defective.	1- Press reset button. 2- If the error is still present (or persists) after reset, notify authorized service of E.C.A.
F52	Error on temperature sensor for domestic water	Temperature sensor for domestic water might be defective.	1- Notify authorized service of E.C.A.
F53	Error on temperature sensor for flue gas	The flue gas temperature sensor is in short or open circuit state.	1- Notify authorized service of E.C.A.
F81	Temperature sensor deviation test delay	Temperature sensors might be defective.	1- Notify authorized service of E.C.A.
F201	Communcation Fault Between Mainboard and MMI	Mainboard-MMI may be failed or communcation cable may be failed.	1- Notify authorized service of E.C.A.
PREDICTIVE MAINTENANCE WARNINGS			
1	Flame Loss Risk	Estimates the device's loss of flame condition.	1- Please contact with authorized service.
2	High Water Pressure Risk	Estimates the device's safety valve opening status.	1- Drain water until the water pressure drops to 1.5-2 bar.
3	Low Water Pressure-Water Leakage Risk"	Plumbing / boiler estimates the water leak situation.	1- Please contact with authorized service.

Table 13.Error Code Table

14-WARRANTY AND SERVICE

Warranty Registration



Scan the QR code to register your warranty or visit www.ecaboilers.co.uk



For Full Terms and Warranty Conditions visit www.ecaboilers.co.uk. The full terms and conditions must be strictly followed in order to manufacturer's warranty valid.

TERMS AND CONDITIONS FOR WARRANTY of ECA Boiler:

1.The appliance has warranty period against product failures in condition that the instructions and precautions in the documents delivered with the product are obeyed. These documents are operating-installation manual and service (includes maintenance operation) manual. The warranty period will not be extended in case of repairing or replacing any product or part. Manufacturer might introduce additional warnings/documents in case needed and deliver with the product. These documents are also binding for the products delivered with the additional documents.

2.The appliance has been used for which it is designed. Heating system inline with product capacity etc.

3.The installation must be carried out only by a registered Gas Safe installer. Benchmark Commissioning checklist must be completed and left with the householder for future reference. Boiler must be registered by either installer or homeowner within 30 days of installation to validate warranty. Should this condition not be met the period of warranty will extend to only 12 months from date of manufacturing on the boiler data plate (in case proof of purchase or benchmark commissioning checklist is not available).

4.At the end of each 12 month period, the boiler must be serviced by a Gas Safe registered engineer according to service manual provided with the boiler. After service operation, Benchmark service record sheet must be completed and left with the householder. Should this condition not be met the boiler warranty will lapse.

5. If the boiler suffers a mechanical or an electrical breakdown please contact your gas safe engineer on +44 800 640 9988

Our normal working times, excluding Bank Holidays are: 8am – 5pm Monday to Friday, 8am – 1pm Saturday, We will arrange for an engineer or appointed contractor, to inspect and repair, or where in our sole opinion repairs not economic, arrange to replace the boiler.

6.We will not accept or reimburse the costs of any third party who undertakes any work carried on the product or fits parts, unless approval is given by the means mentioned in point 5 such work in advance of it being carried out.

7.The boiler has to be installed at an accessible area where Engineers can perform servicing without health and safety risk.

8.Cupboard installations must provide minimum working clearances as detailed in the installation manual. Homeowner will provide removal of cupboards, kitchen units or trims in order to gain access for service.

9.The warranty does not apply:

a.If the boiler is removed from its place of installation and/or installation interfaces have been changed without our prior consent.

b.E.C.A will not accept responsibility for damage caused by faulty installation, neglect, misuse or accidental damage, the non-observance of the instructions contained in the service manual.

c.To any defect, damage or breakdown caused by the installation and maintenance of the CH system.

d.Noisy boiler, cold spots on radiators, sludge in pipes and poor circulation of the central heating system caused by any damage due to scaling, sludge or blockages as a result of hard water, scale, deposits, damage, aggressive water or sludge due to corrosion. Subsequently maintenance and cleaning of the system.

e.If the contact procedure defined in point 5 is not adhered to

f.To any other costs or expenses caused by or arising due to the breakdown of an E.C.A. Boiler.

g.Damage caused by faulty installation (boiler, flue system or condensate discharge), theft, tampering, neglect, misuse, accident, fire, flood, explosion, lightning, storms, earthquake, frost or other bad weather conditions.

h.To any costs incurred during delays in fixing reported faults.

i.Costs of each annual maintenance, including parts such as seals or electrodes replaced at this time

j.Any problems caused by inadequate supply of services such as electricity, gas or water to the property.

k.The boilers which are not installed and set up strictly in line with the installation instructions supplied with them (including the requirement to clean the system and add corrosion inhibitor in line with BS7593:1992).

l.where spare parts other than E.C.A. parts have been used in any service or repair. In this case, the warranty for such products is not valid furthermore.

m.Theft or attempted theft

n.Self-maintenance tasks such as re-pressurizing and resetting the boiler, bleeding excess system pressure and thawing frozen condensate pipes.

10.Visits by the service personnel would be charged to customer if;

a)any failure caused by contaminated water in the system

b)the boiler is not accessible or an engineer cannot gain access to the property

c)a fault cannot be found.

d)Benchmark commissioning sheet or equivalent control document is not available.

e)Failure to cancel an agreed appointment prior to our engineers visit at least before 12 noon on the day preceding the agreed appointment in order to arrange an alternative date.

f)The boiler is outside the period of warranty or any warranty ending condition mentioned in point 9 occurs.

g)the fault is not product related, or alternatively if the fault is due to an installation error or because the system requires cleansing. Our engineer will advise you of this on the day and we reserve the right to charge an inspection fee.

11.The customer is responsible for the following points during visits by the service personnel;

a.The customer is has to be available to be contacted 30 minutes prior to the appointment. If not, our engineer will proceed to attend the appointment.

b.You are responsible for providing adequate parking for our engineer.

c.Our engineers are entitled to work in a smoke free environment and as such, you are required to ensure that the engineer is not exposed to active smoking whilst he is within the property.

d.It is your responsibility to ensure that pets are away from the area where the engineer needs to work

e.We reserve the right to cancel an appointment and to retain an inspection fee should legal parking not be provided, or if we are unable to obtain clear and safe access to the property or product, or if we have reason to believe that the health and safety of our engineer cannot be guaranteed.

f.If chargeable works are required, we will not service until payment is made.

g.We reserve the right to not fulfill an appointment, should the necessary spares be unavailable, if the product is subject to recall or if the product has become obsolete and removed from our current product list.

h.For all engineer visits out of warranty we will normally ask for payment details (credit/debit card) prior to booking an engineer appointment. These details will be used to reserve our charge on your account. Once the engineer appointment is concluded this charge will then be debited from your account.

i.You are required to provide telephone contact numbers to enable us to contact you in the course of arranging and fulfilling your appointment. In the course of arranging and fulfilling your appointment we may choose to contact you via phone, text, fax or e-mail.

Charges

- Servicing and Commissioning appointments are charged at a fixed price inclusive of VAT, with the price being dependant on the product. Spare Parts Guarantee

- Any parts fitted under one of the chargeable call types above are guaranteed for one calendar year against defective workmanship and defective components.

- If we fit replacement parts or replace a boiler it will not extend the period of the warranty. All replaced parts or boilers will become the property of E.C.A.

- If your service visit was done on a fixed charge basis and it becomes evident, within 30 days of the original appointment, that your product has not been successfully repaired then we will return to repair the product free of charge, but subject to the same terms and conditions. If however, a new fault has developed since the original appointment, then we reserve the right to charge for the second appointment in line with our terms and conditions.

If you smell gas or are worried about gas safety, you can call the National Gas Emergency Service free on 0800 111 999 at any time, day or night.

This boiler warranty is offered in addition to the rights provided to a consumer by law. Details of these rights can be obtained from a Trading Standards Authority or a Citizen Advice Bureau.

We reserve the right to update or amend these Terms and Conditions at any time and its decision in relation to warranty claims shall be final.

Your guarantee is provided to you by **ARD London (registered in England with company number +44 800 640 9988 or +44 20 3978 1212)** of Guarantor – ARD London , Adres: 15 / a Raven Road London E18 1HB

Data Protection

Your details will be kept safe and secure, only used by us or those who partner with us, and will not be shared with anyone else. By submitting your details, you are telling us that you are okay with this and that you agree with our privacy notice. You can of course, change your mind at any time. If you have given us permission, your details may also be used by us or third parties for other marketing purposes. We and the third parties (if applicable) may contact you by mail, telephone or email. If you no longer want your data to be used by third parties or by us for marketing purposes, please contact us.

ADDITIONAL RECOMMENDATIONS by ECA to CUSTOMER TO HAVE HIGH HEATING PERFORMANCE:

Make sure that the heating system is clean. Power flushing is the most efficient and effective method of cleaning a central heating system. The principle is to create a powerful fresh water flow under controlled conditions to remove debris from the system. By connecting the power flushing unit to the heating circuit in place of the system pump, boiler or radiator the system can be thoroughly cleaned of lime scale and corrosion debris. Without using correct water treatment, corrosion debris will accumulate in the boiler causing.

Lime scale deposition cause up to 30% of the system's fuel consumption being wasted. The noise of boiler increases as deposits of sludge and scale build-up in an unprotected boiler. The deposits gathering in the waterways of the boiler are causing the heat transfer loss and flow noise.

In your heating system use proposed inhibitors as Fernox and Sentinel.

We also advice to use magnetic cleaners for your heating system.

Performing the maintenance once a year during the warranty period and periodically before the winter season after the warranty expires ensures safe use, saves fuel and extends the useful life of the boiler. Make sure periodic maintenance is strictly performed by E.C.A. Authorized Services.

15-ANNEXES

15.1 Characteristic Curve of Water Pressure Height of The Pump (Pump Head- Flow Rate) 15-60 (for 14/20/24/28/30 kW Models)

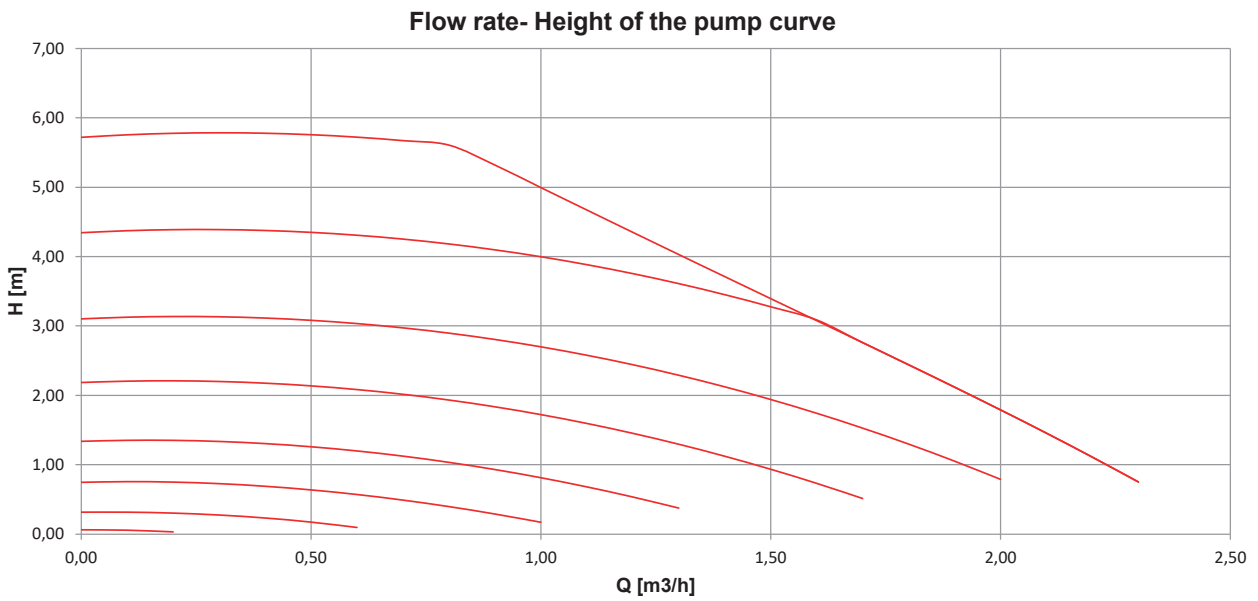

Graph 1

15-70 (for 35 kW Model)

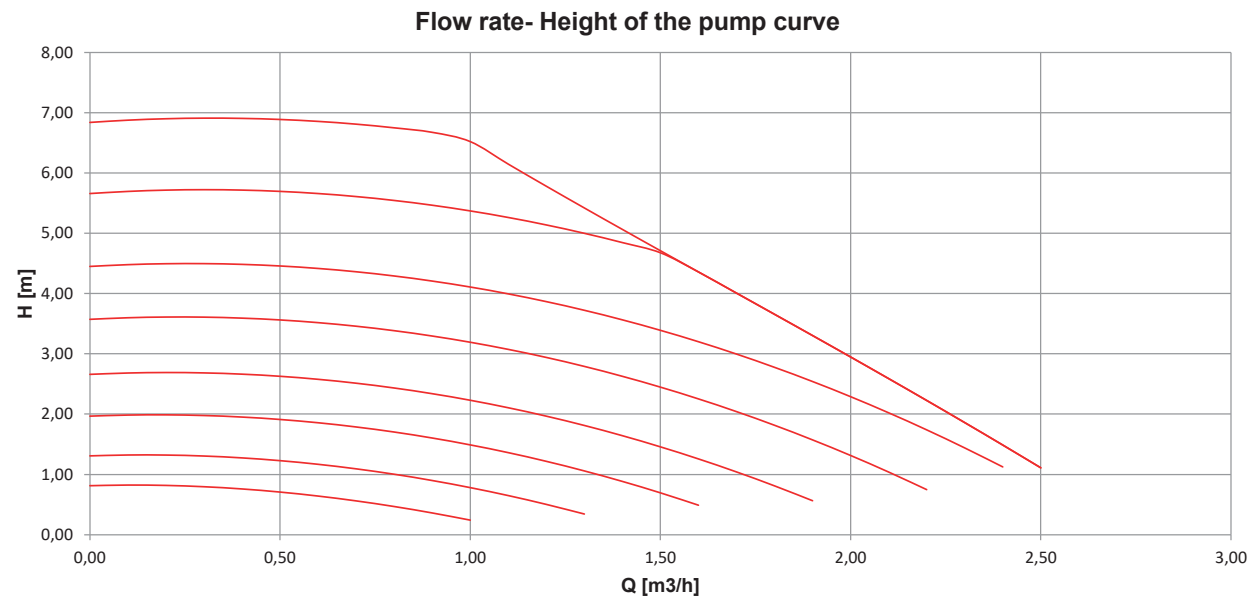

Graph 2

16-SPARE PART LIST















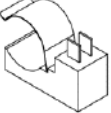
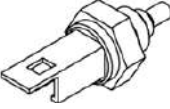
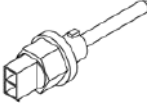

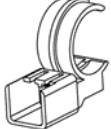

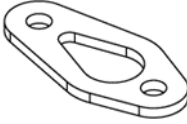
 <p>7006907245 MOTORIZED VALVE</p>	 <p>7006907924 EXPANSION VESSEL</p>	 <p>7006990002 GAS VALVE</p>	 <p>7006990148 FAN</p>	 <p>7006991208 WRAS APPROVED FILLING LOOP</p>
 <p>7006907505 SURFACE TYPE NTC</p>	 <p>7006907917 IMMERSION TYPE NTC</p>	 <p>7006951197 FLUE GAS SENSOR</p>	 <p>7006952680 WATER PRESSURE SENSOR</p>	 <p>7006985262 TURBINE GROUP</p>
 <p>7006985271 FLOW SENSOR GROUP</p>	 <p>7006990316 SAFETY VALVE</p>	 <p>7006990260 ELECTRODE GASKET</p>	 <p>7006990257 ELECTRODE</p>	 <p>7006990254 BURNER</p>
 <p>7006901445 CERAMIC 2A FUSE</p>	 <p>7006990251 IGNITION ELECTRODE CABLE</p>	 <p>7006990120 HIGH VOLTAGE CABLE</p>	 <p>7006990121 LOW VOLTAGE FAN CABLE</p>	 <p>7006990174 LOW VOLTAGE FLOW SENSOR CABLE</p>
 <p>7006990320 GAS ORRIFICE 24 kW 7006990688 GAS ORRIFICE 30 kW 7006990690 GAS ORRIFICE 35 kW</p>	 <p>7006990204 PUMP 24/30 kW 7006990205 PUMP 35 kW</p>	 <p>7006990144 P.HEX 24 kW 7006990194 P.HEX 30 kW 7006990195 P.HEX 35 kW</p>	 <p>7006990119 MAINBOARD 24 kW 7006990210 MAINBOARD 30 kW 7006990299 MAINBOARD 35 kW</p>	 <p>7006990310 FLOW LIMITOR 24 kW 7006990311 FLOW LIMITOR 30 kW 7006990312 FLOW LIMITOR 35 kW</p>

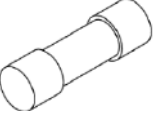
Table 14. Spare Part List

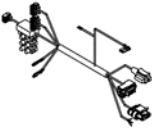
GAS BOILER SYSTEM COMMISSIONING CHECKLIST

This Commissioning Checklist is to be completed in full by the competent person who commissioned the boiler as a means of demonstrating compliance with the appropriate Building Regulations and then handed to the customer to keep for future reference.

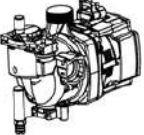
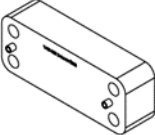
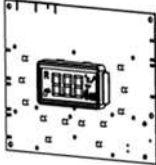
Failure to install and commission according to the manufacturer's instructions and complete this Benchmark Commissioning Checklist will invalidate the warranty. This does not affect the customer's statutory rights.

Customer name:					Telephone number:								
Address:													
Boiler make and model:													
Boiler serial number:													
Commissioned by (PRINT NAME):					Gas Safe register number:								
Company name:					Telephone number:								
Company address:													
					Commissioning date:								
To be completed by the customer on receipt of a Building Regulations Compliance Certificate*													
Building Regulations Notification Number (if applicable):													
CONTROLS (tick the appropriate boxes)													
Time and temperature control to heating		Room thermostat and programmer/timer			Programmable room thermostat								
		Load/weather compensation			Optimum start control								
Time and temperature control to hot water		Cylinder thermostat and programmer/timer			Combination Boiler								
Heating zone valves		Fitted			Not required								
Hot water zone valves		Fitted			Not required								
Thermostatic radiator valves		Fitted			Not required								
Automatic bypass to system		Fitted			Not required								
Boiler interlock					Provided								
ALL SYSTEMS													
The system has been flushed and cleaned in accordance with BS7593 and boiler manufacturer's instructions								Yes					
What system cleaner was used?													
What inhibitor was used?								Quantity		litres			
Has a primary water system filter been installed?								Yes		No			
CENTRAL HEATING MODE measure and record:													
Gas rate		m ³ /hr		OR		ft ³ /hr							
Burner operating pressure (if applicable)		mbar		OR Gas inlet pressure		mbar							
Central heating flow temperature								°C					
Central heating return temperature								°C					
COMBINATION BOILERS ONLY													
Is the installation in a hard water area (above 200ppm)?								Yes		No			
If yes, and if required by the manufacturer, has a water scale reducer been fitted?								Yes		No			
What type of scale reducer has been fitted?													
DOMESTIC HOT WATER MODE Measure and Record:													
Gas rate		m ³ /hr		OR		ft ³ /hr							
Burner operating pressure (at maximum rate)		mbar		OR Gas inlet pressure at maximum rate		mbar							
Cold water inlet temperature								°C					
Hot water has been checked at all outlets								Yes	Temperature	°C			
Water flow rate								l/min					
CONDENSING BOILERS ONLY													
The condensate drain has been installed in accordance with the manufacturer's instructions and/or BS5546/BS6798								Yes					
ALL INSTALLATIONS													
Record the following:		At max. rate:		CO		ppm		AND		CO/CO ₂		Ratio	
		At min. rate: (where possible)		CO		ppm		AND		CO/CO ₂		Ratio	
The heating and hot water system complies with the appropriate Building Regulations										Yes			
The boiler and associated products have been installed and commissioned in accordance with the manufacturer's instructions										Yes			
The operation of the boiler and system controls have been demonstrated to and understood by the customer										Yes			
The manufacturer's literature, including Benchmark Checklist and Service Record, has been explained and left with the customer										Yes			
Commissioning Engineer's Signature													
Customer's Signature													
(To confirm satisfactory demonstration and receipt of manufacturer's literature)													

*All installations in England and Wales must be notified to Local Authority Building Control (LABC) either directly or through a Competent Persons Scheme. A Building Regulations Compliance Certificate will then be issued to the customer.



SERVICE RECORD

It is recommended that your heating system is serviced regularly and that the appropriate Service Interval Record is completed.

Service Provider

Before completing the appropriate Service Record below, please ensure you have carried out the service as described in the manufacturer's instructions. Always use the manufacturer's specified spare part when replacing controls.

SERVICE 01					Date:
Engineer name:					
Company name:					
Telephone No:					
Gas safe register No:					
Record:	At max. rate:	CO	ppm	AND	CO ₂ %
	At min. rate: (Where Possible)	CO	ppm	AND	CO ₂ %
Comments:					
Signature					

SERVICE 02					Date:
Engineer name:					
Company name:					
Telephone No:					
Gas safe register No:					
Record:	At max. rate:	CO	ppm	AND	CO ₂ %
	At min. rate: (Where Possible)	CO	ppm	AND	CO ₂ %
Comments:					
Signature					

SERVICE 03					Date:
Engineer name:					
Company name:					
Telephone No:					
Gas safe register No:					
Record:	At max. rate:	CO	ppm	AND	CO ₂ %
	At min. rate: (Where Possible)	CO	ppm	AND	CO ₂ %
Comments:					
Signature					

SERVICE 04					Date:
Engineer name:					
Company name:					
Telephone No:					
Gas safe register No:					
Record:	At max. rate:	CO	ppm	AND	CO ₂ %
	At min. rate: (Where Possible)	CO	ppm	AND	CO ₂ %
Comments:					
Signature					

SERVICE 05					Date:
Engineer name:					
Company name:					
Telephone No:					
Gas safe register No:					
Record:	At max. rate:	CO	ppm	AND	CO ₂ %
	At min. rate: (Where Possible)	CO	ppm	AND	CO ₂ %
Comments:					
Signature					

SERVICE 06					Date:
Engineer name:					
Company name:					
Telephone No:					
Gas safe register No:					
Record:	At max. rate:	CO	ppm	AND	CO ₂ %
	At min. rate: (Where Possible)	CO	ppm	AND	CO ₂ %
Comments:					
Signature					

SERVICE 07					Date:
Engineer name:					
Company name:					
Telephone No:					
Gas safe register No:					
Record:	At max. rate:	CO	ppm	AND	CO ₂ %
	At min. rate: (Where Possible)	CO	ppm	AND	CO ₂ %
Comments:					
Signature					

SERVICE 08					Date:
Engineer name:					
Company name:					
Telephone No:					
Gas safe register No:					
Record:	At max. rate:	CO	ppm	AND	CO ₂ %
	At min. rate: (Where Possible)	CO	ppm	AND	CO ₂ %
Comments:					
Signature					

SERVICE 09					Date:
Engineer name:					
Company name:					
Telephone No:					
Gas safe register No:					
Record:	At max. rate:	CO	ppm	AND	CO ₂ %
	At min. rate: (Where Possible)	CO	ppm	AND	CO ₂ %
Comments:					
Signature					

SERVICE 10					Date:
Engineer name:					
Company name:					
Telephone No:					
Gas safe register No:					
Record:	At max. rate:	CO	ppm	AND	CO ₂ %
	At min. rate: (Where Possible)	CO	ppm	AND	CO ₂ %
Comments:					
Signature					

*All installations in England and Wales must be notified to Local Authority Building Control (LABC) either directly or through a Competent Persons Scheme. A Building Regulations Compliance Certificate will then be issued to the customer.





PRODUCTION

EMAS MAKİNA SANAYİ A.Ş Organize Sanayi Bölgesi

3. Kısım Mustafa Kemal Bulvarı No:13 45030 MANİSA

Phone: + 90 236 213 00 21

Fax: + 90 236 213 08 59

E-mail: emas@emas.com.tr www.emas.com.tr

SALES & TECHNICAL SUPPORT

Call Center Tel:+44 800 640 9988

Office Tel : +44 203 978 1212

Adress : 15 / A Raven Road London E18 1HB

Activating your quarantee is quick and simple , but really important!

Register at

www.ecaboilers.co.uk/warranty-registration

complete and return in the envelope provided

QR code



scan me

7006991953_1.0

